

KOJEX

KOJEX



COMPANY INTRODUCES

Kojex Machinery Industrial Co., Ltd established in 1988, which are mainly producing collets and collet chucks.

KOJEX is the earliest factory to produce ER collets in Taiwan as well. The demands for higher precision and rigidity of collets shown in the market due to the high speed trend of machine centers and popularization of carbide tools. Thus, the company strived to improve the deficiencies of ER system and developed SD and HEC series products, which receive warm welcome in the market.

KOJEX is the initiator of inner-holding collet chucks.

廣傑公司成立於1988年，以生產筒夾及筒夾柄為主。

廣傑公司是台灣最早生產ER筒夾的工廠，由於數控銑床的高速化及碳化鎢刀具使用的普及化，市場對筒夾的精度及剛性的需求提高。公司因此努力改良ER的缺點，發展出SD及HEC系統產品，廣受市場歡迎。

廣傑公司是後拉式夾頭的創始者。

”

More than 20 years

KOJEX has only focused on one thing.



KOJEX has its own research and development department and created inner-holding UC and DC series of collet and collet chuck, changing the traditional collet chuck with nut. In the territories of high-speed and heavy cutting, UC and DC series spread out an extraordinary and are popular among customers who pursue high efficiency.

KOJEX only focused on one thing over 20 years, that is, research and development as well as manufacture of collet and collet chuck.

Our mission is providing satisfying products for customers. In order to meet with diversified demands of our customers, the company strictly complies with the following principals.

公司的宗旨是提供客戶滿意的產品，為了滿足客戶多方面的需求，廣傑公司嚴格遵守以下的標準：

EXCELLENT QUALITY

1

Every product of KOJEX under the full quality assurance of strict examination.

每一件KOJEX產品均經100%的嚴格品質檢驗。



PRODUCTION SYSTEM

2

Flow serial number system for retracing the full production flow of our products.

流程序號制度，可追溯產品的整個生產流程。



ADEQUATE INVENTORY

3

Sufficient stock supply. Keeping in stock for 95% of the specifications on our products catalogue.

庫存充足，目錄上有的規格，95%以上均有庫存品。



FAST DELIVERY

4

Delivery within 24 hours upon an order confirmation.

交貨快速，訂單確定後，24小時內可出貨。



KODAK





INDEX | 索引

| UC / P01 - P22

| DC / P23 - P36

| HEC / P37 - P44

| SD / P45 - P60

| HPC / P61 - P65

| PULL STUDS / P66 - P67

| USER MANUAL / P68

UC

BRAND NEW GOLD CHUCK
AN EXCITING RESULT.

—
一種全新感受的刀柄
創造令人振奮的成績





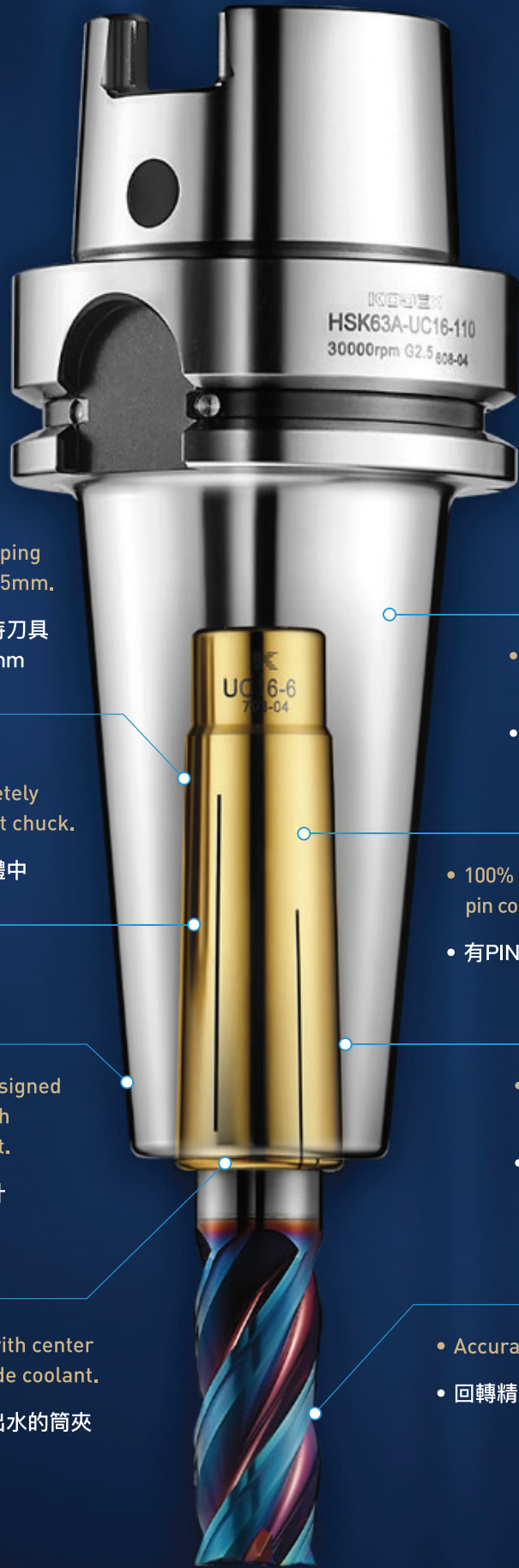

- Complete tool clamping range from 3mm~25mm.

- 規格種類齊全，夾持刀具的範圍：3mm~25mm

- The collet is completely covered in the collet chuck.

- 筒夾完全包覆在本體中

- The collet chuck designed without nut and with inner-holding collet.

- 沒有螺帽的刀柄設計

- Provide the collet with center coolant and with side coolant.

- 有中心出水及側面出水的筒夾可供選擇

- Excellent vibration damping of performance.

- 極佳的阻尼減震性能

- 100% never tool pull out for the pin collet.

- 有PIN的筒夾設計，100%不掉刀

- The inner-holding collet designed of small angle.

- 小角度的後拉式筒夾設計

- Accuracy < 0.005mm (4XD)

- 回轉精度在0.005mm以下 (4XD)

RUN OUT

Accuracy within 0.005mm at 4 times length of cutter edge to ensure uniform an even cutting action, increasing cutting speed and tool life.

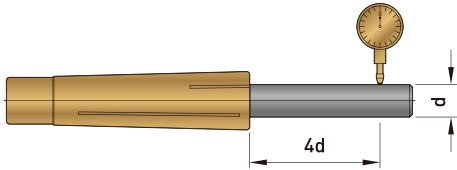

回轉精度

4倍刃長精度在0.005mm以內，確保切削時每刃刀口的均勻切削，可使切削速度提高及刀具壽命增加。

CHOICE OF COOLING MODE

Provide the collet with center coolant and with side coolant.

— 冷却方式的選擇

有中心出水及側面出水的筒夾，可供選擇。

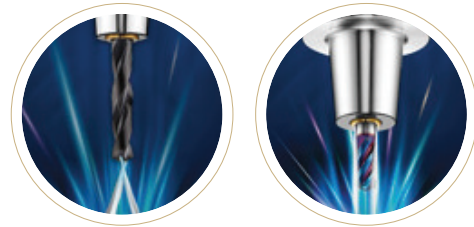

EXCELLENT VIBRATION DAMPING OF PERFORMANCE

The inner-holding collet designed of small angle can completely covered in the collet chuck that can increasing clamping force and having the excellent vibration damping of performance for get the maximum benefit from the machine and tools.



— 極佳的阻尼減震性能

小角度後拉式筒夾設計，筒夾完全包覆在本體內，鎖固力量大，具有極佳的阻尼減震性能，可使機床及刀具發揮到最大的效益。

INNOVATION DESIGNED AND 100% NEVER TOOL PULL OUT

The collet designed with pin can be fixed the standard side lock tool (DIN6535HB) or grinded R groove at tools with excellent vibration damping and 100% never tool pull out.

— 創新設計，100%不掉刀

有PIN的筒夾設計，可以固定標準側固刀具 [DIN6535HB] 或者自行在柄部研磨R型溝槽，具有極佳的阻尼減震及100%不掉刀的雙重效果。

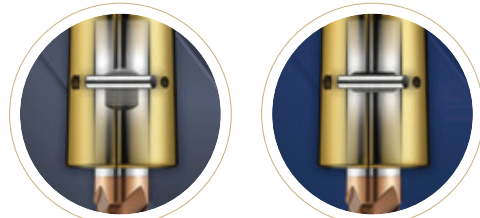

WELDON TYPE

R GROOVE

KOJEX IS THE INITIATOR OF INNER-HOLDING COLLET CHUCKS

The simple structure can reduces interference and more stable when the cutting processing.

— 廣傑獨創

沒有螺帽的筒夾設計

沒有螺帽的筒夾設計，結構簡單減少干涉，切削時更為安定。



COMPLETE VARIETY

Either the slim extension or the vibration damping tool holder has the clamping range from 3 mm to 25 mm.

— 規格種類齊全

無論小徑加長型或減震阻尼型均有，刀具夾持範圍：
3mm~25 mm



UC GOLD CHUCK

UC 黃金夾頭刀柄

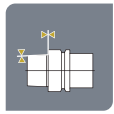
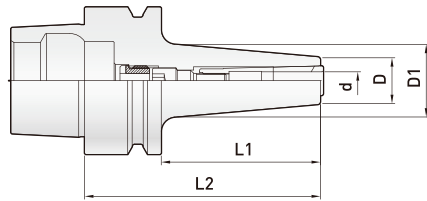

Dual face contact
兩面接觸



Surface roughness
表面粗度

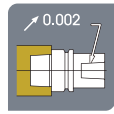

Run out accuracy
內孔偏擺度



Surface hardness
表面硬度

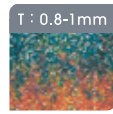

Carbonized depth
滲碳深度

Order Code 訂購編號	Range(d) 夾持範圍	L	L1	D	D1	Min ⁻¹ G2.5 動態平衡	Spanner 扳手規格	Recommended Torsion 推薦鎖固扭力	Fixed Torque Spanner 固定扭力扳手
HSK40E-UC6-80	3~6	80	60	16	26	42,000	M4	5Nm	30294-5144
UC10-90	3~10	90	90	24	32	42,000	M5	7Nm	30294-5152
HSK50E-UC6-80	3~6	80	54	16	25	36,000	M4	5Nm	30294-5144
UC10-90	3~10	90	64	24	35	36,000	M5	7Nm	30294-5152

- Collet chuck designed without nut and with inner-holding collet. This has strong rigidity and high stability.
- Torque wrench is recommended for chuck stability.
- Torque wrench must be ordered separately.
- The recommended torsion and correct torque wrench prevents deformation of the tool holder.

- 沒有螺帽的後拉式夾頭設計，鋼性強穩定性高。
- 為求使用上的穩定性，建議使用扭力扳手。
- 扭力扳手必須另外訂購。
- 鎖固扭力不要超過推薦值的30%以上，過高的鎖固扭力，可能導致刀柄的變形。



UC GOLD CHUCK (Slim Long Type)

UC 黃金夾頭刀柄 (小徑加長型)

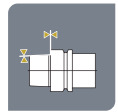
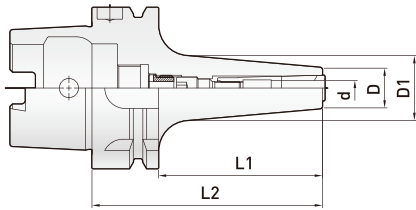

Dual face contact
兩面接觸



Surface roughness
表面粗度

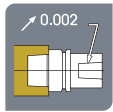

Run out accuracy
內孔偏擺度



Surface hardness
表面硬度

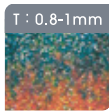

Carbonized depth
滲碳深度

Order Code 訂購編號	Range(d) 夾持範圍	L	L1	D	D1	Min ¹ G2.5 動態平衡	Spanner 扳手規格	Recommended Torsion 推薦鎖固扭力	Fixed Torque Spanner 固定扭力扳手
HSK63A-UC6-90	3~6	90	64	16	26	30,000	M4	5Nm	30294-5146
UC6-120	3~6	120	94	16	32	30,000	M4	5Nm	30294-5146
UC6-150	3~6	150	124	16	37	30,000	M4	5Nm	30294-5146
HSK63A-UC10-100	3~10	100	74	24	34	30,000	M5	7Nm	30294-5154
UC10-120	3~10	120	94	24	40	30,000	M5	7Nm	30294-5156
UC10-150	3~10	150	124	24	46	30,000	M5	7Nm	30294-5156

- Collet chuck designed without nut and with inner-holding collet. This has strong rigidity and high stability.
- Torque wrench is recommended for chuck stability.
- Torque wrench must be ordered separately.
- The recommended torsion and correct torque wrench prevents deformation of the tool holder.

- 沒有螺帽的後拉式夾頭設計，鋼性強穩定性高。
- 為求使用上的穩定性，建議使用扭力扳手。
- 扭力扳手必須另外訂購。
- 鎖固扭力不要超過推薦值的30%以上，過高的鎖固扭力，可能導致刀柄的變形。



UC

HSK

A63

UC GOLD CHUCK (UC16) High Vibration Damping Type

UC 黃金夾頭刀柄 (UC16) 高阻尼減震型

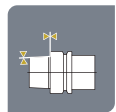
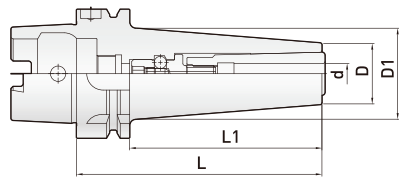

Dual face contact
兩面接觸

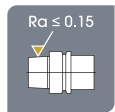

Surface roughness
表面粗度

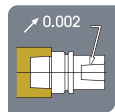

Run out accuracy
內孔偏擺度

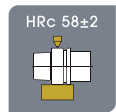

Surface hardness
表面硬度

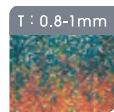

Carbonized depth
滲碳深度



Order Code 訂購編號	Range(d) 夾持範圍	L	L1	D	D1	Min ¹ G2.5 動態平衡	Spanner 扳手規格	Recommended Torsion 推薦鎖固扭力	Torque Wrench 扭力扳手	Center Coolant 中心出水	Side Coolant 側面出水	Pin Collet Pin 筒夾
HSK63A-UC16-120	6~16	120	94	32	47	30,000	M6	15Nm	TW30+M06100	✓	✓	X
HSK100A-UC16-150	6~16	150	121	32	49	20,000	M6	15Nm	TW30+M06160	✓	✓	X

- Provide the center coolant and the side coolant.
- Select the side coolant must use the collet with coolant slot, please check p.20
- Select the general collet for center coolant, please check p.19
- Coolant can be sprayed directly into the edge of tool for quick cooling and remove the steel chip.

- 可以選擇中心出水及側面出水的功能。
- 側面出水必須選用有水槽的夾頭，請參閱 p.20
- 中心出水選用一般的夾頭，請參閱 p.19
- 冷却液可直接噴到刀尖位置，可快速冷却及去除鐵屑。



UC GOLD CHUCK (UC20) High Vibration Damping Type

UC 黃金夾頭刀柄 (UC20) 高阻尼減震型

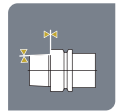
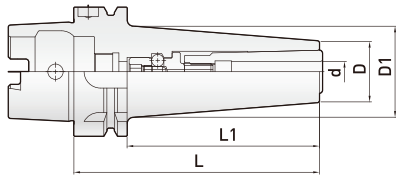

Dual face contact
兩面接觸



Surface roughness
表面粗度

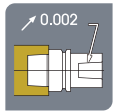

Run out accuracy
內孔偏擺度



Surface hardness
表面硬度

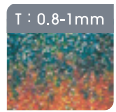

Carbonized depth
滲碳深度

Order Code 訂購編號	Range(d) 夾持範圍	L	L1	D	D1	Min ⁻¹ G2.5 動態平衡	Spanner 扳手規格	Recommended Torsion 推薦鎖固扭力	Torque Wrench 扭力扳手	Center Coolant 中心出水	Side Coolant 側面出水	Pin Collet Pin筒夾
HSK63A-UC20-130	6~20	130	104	45	53	30,000	M8	20Nm	TW30+M08100	✓	✓	✓
HSK100A-UC20-150	6~20	150	121	45	54	20,000	M8	20Nm	TW30+M08160	✓	✓	✓

- Provide the center coolant and the side coolant.
- Select the side coolant must use the collet with coolant slot, please check p.20
- Select the general collet for center coolant, please check p.19
- Select the PIN Collet, please check p.21
- Coolant can be sprayed directly into the edge of tool for quick cooling and remove the steel chip.

- 可以選擇中心出水及側面出水的功能。
- 側面出水必須選用有水槽的夾頭，請參閱 p.20
- 中心出水選用一般的夾頭，請參閱 p.19
- 可以選用PIN Collet，請參閱 p.21
- 冷却液可直接噴到刀尖位置，可快速冷却及去除鐵屑。



UC
20

HSK
A
63
/
100

UC PIN COLLET CHUCK (UC25) High Vibration Damping Type

UC 安卡夾頭 (UC25) 高阻尼減震型

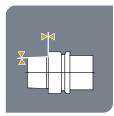
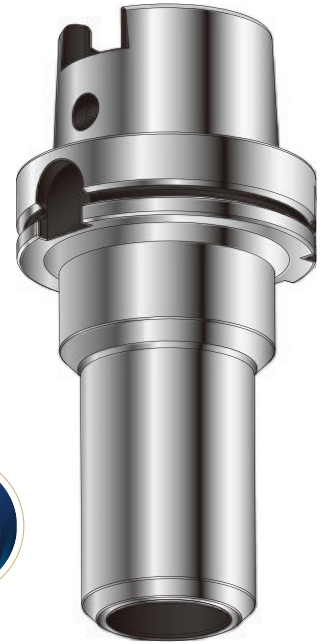
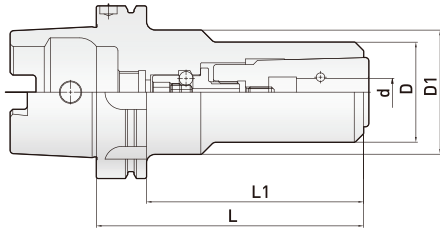

Dual face contact
兩面接觸



Surface roughness
表面粗度

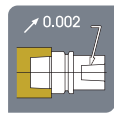

Run out accuracy
內孔偏擺度

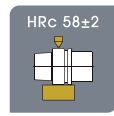

Surface hardness
表面硬度

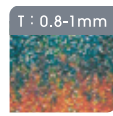

Carbonized depth
滲碳深度



Order Code 訂購編號	Range(d) 夾持範圍	L	L1	D	D1	Min ¹ G2.5 動態平衡	Spanner 扳手規格	Recommended Torsion 推薦鎖固扭力	Torque Wrench 扭力扳手
HSK100A-UC25-160	12-25	160	136	58	72	20,000	M10	25Nm	TW30+M10100

- The collet designed with PIN, 100% never tool pull out.
- Must be used R groove tool or standard specifications DIN 6535 HB for side lock tool.
- Must to choose the Pin collet, please check p.21

- 有PIN的夾頭設計，100%不掉刀。
- 必須使用R型溝槽刀具或標準規範DIN 6535 HB的側固刀具。
- 必須選用有PIN的筒夾，請參閱 p.21



CENTER COOLANT

| 中心出水 |

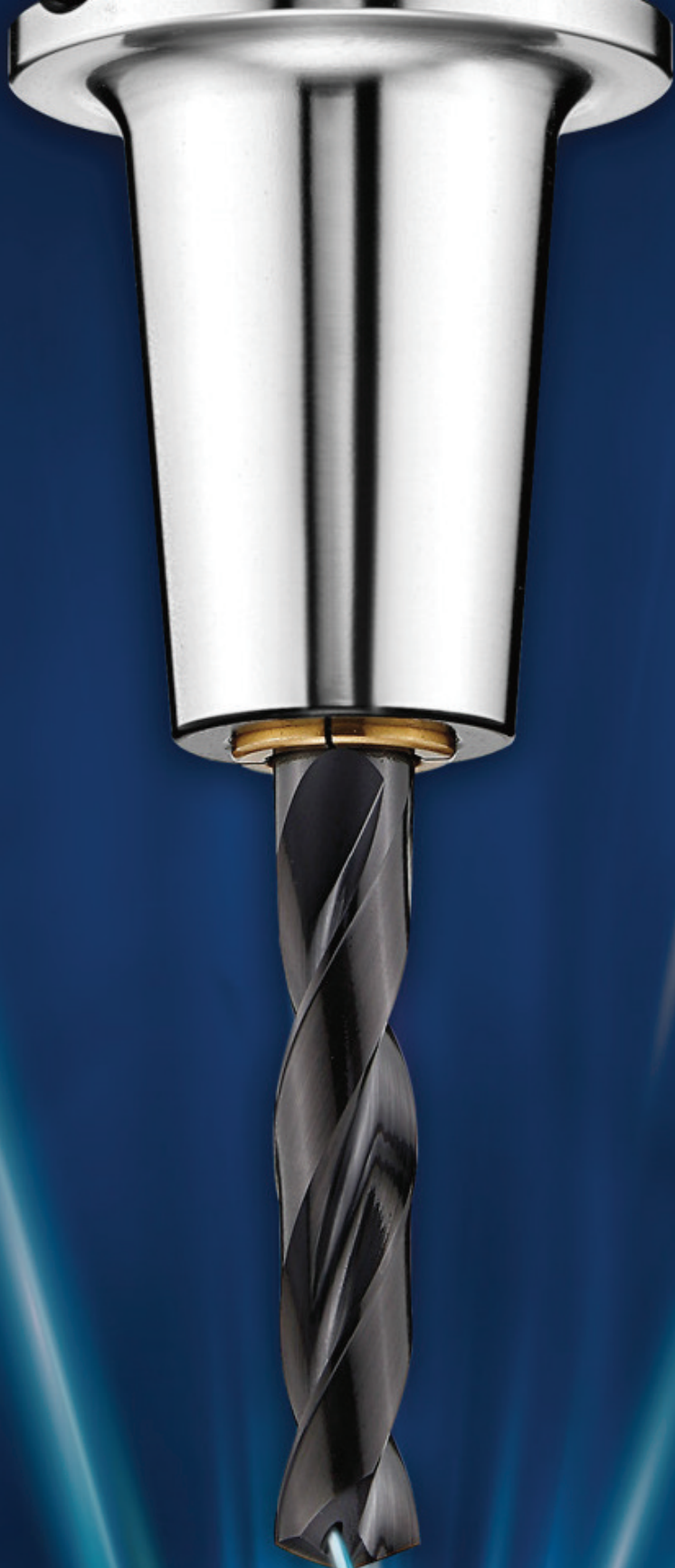

UC GOLD CHUCK (UC6) Slim Long Type

UC 黃金夾頭刀柄 (UC6) 小徑加長型

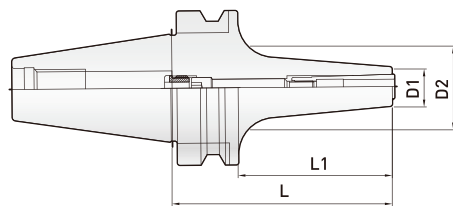
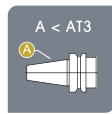
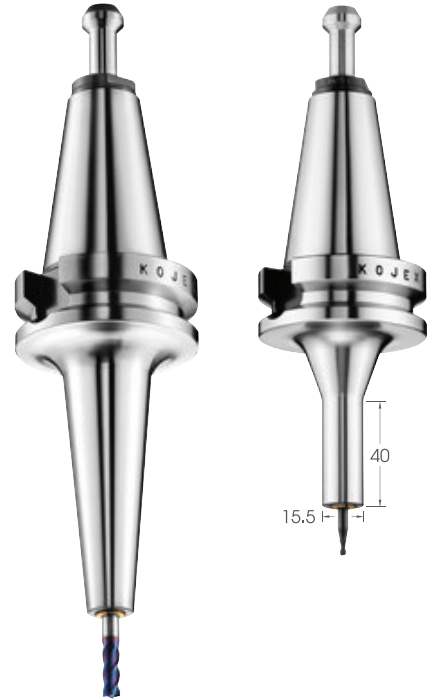
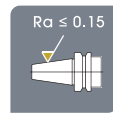

Fig 1 / 圖號 1

Fig 2 / 圖號 2



Taper tolerance
錐度公差



Surface roughness
表面粗度

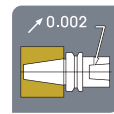

Run out accuracy
內孔偏擺度



Surface hardness
表面硬度

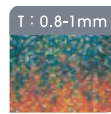

Carbonized depth
滲碳深度

Order Code 訂購編號	L	L1	D1	D2	Fig 圖號	Min ⁻¹ G2.5 動態平衡	Spanner 扳手規格	Recommended Torsion 推薦鎖固扭力	Fixed Torque Spanner 固定扭力扳手
BT30-UC6-70	70	48	16	24	1	30,000	M4	5Nm	30294-5144
UC6-90	90	68	16	29	1	30,000	M4	5Nm	30294-5144
UC6-120	120	98	16	33	1	30,000	M4	5Nm	30294-5144
BT40-UC6-90	90	63	16	27	1	30,000	M4	5Nm	30294-5144
UC6-90T	90	63	15.5	32	2	30,000	M4	5Nm	30294-5144
UC6-120	120	93	16	32	1	30,000	M4	5Nm	30294-5146
UC6-150	150	123	16	38	1	30,000	M4	5Nm	30294-5146

- Collet chuck designed without nut and with inner-holding collet. This has strong rigidity and high stability.
- Torque wrench is recommended for chuck stability.
- Torque wrench must be ordered separately.
- The recommended torsion and correct torque wrench prevents deformation of the tool holder.

- 沒有螺帽的後拉式夾頭設計，鋼性強穩定性高。
- 為求使用上的穩定性，建議使用扭力扳手。
- 扭力扳手必須另外訂購。
- 鎖固扭力不要超過推薦值的30%以上，過高的鎖固扭力，可能導致刀柄的變形。



UC GOLD CHUCK (UC10)

UC 黃金夾頭刀柄 (UC10)

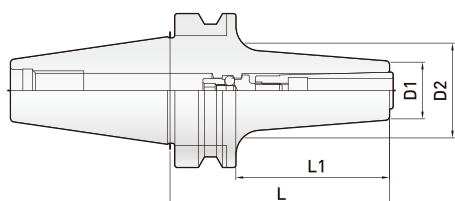
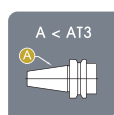

Fig 1 / 圖號 1



Fig 2 / 圖號 2



Taper tolerance
錐度公差

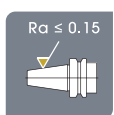

Surface roughness
表面粗度

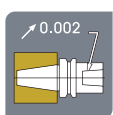

Run out accuracy
內孔偏擺度

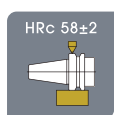

Surface hardness
表面硬度

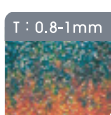

Carbonized depth
滲碳深度

Slim Long Type 小徑加長型

Order Code 訂購編號	L	L1	D1	D2	Fig 圖號	Min ⁻¹ G2.5 動態平衡	Spanner 扳手規格	Recommended Torsion 推薦鎖固扭力	Fixed Torque Spanner 固定扭力扳手
BT30-UC10-70	70	48	24	32	1	30,000	M5	7Nm	30294-5152
BT40-UC10-90	90	63	24	35	1	30,000	M5	7Nm	30294-5154
UC10-120	120	93	24	40	1	30,000	M5	7Nm	30294-5156
UC10-150	150	123	24	46	1	30,000	M5	7Nm	30294-5156
BT50-UC10-110	110	72	24	36	1	20,000	M5	7Nm	30294-5156
UC10-150	150	112	24	43	1	20,000	M5	7Nm	30294-5158
UC10-200	200	162	24	52	1	20,000	M5	7Nm	30294-5159

High Vibration Damping Type 高阻尼減震型

BT40-UC10-70	70	38	30	37.5	2	30,000	M5	7Nm	30294-5152
--------------	----	----	----	------	---	--------	----	-----	------------

- Collet chuck designed without nut and with inner-holding collet. This has strong rigidity and high stability.
- Torque wrench is recommended for chuck stability.
- Torque wrench must be ordered separately.
- The recommended torsion and correct torque wrench prevents deformation of the tool holder.

- 沒有螺帽的後拉式夾頭設計，鋼性強穩定性高。
- 為求使用上的穩定性，建議使用扭力扳手。
- 扭力扳手必須另外訂購。
- 鎖固扭力不要超過推薦值的30%以上，過高的鎖固扭力，可能導致刀柄的變形。



UC GOLD CHUCK (UC16) High Vibration Damping Type

UC 黃金夾頭刀柄 (UC16) 高阻尼減震型

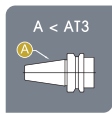
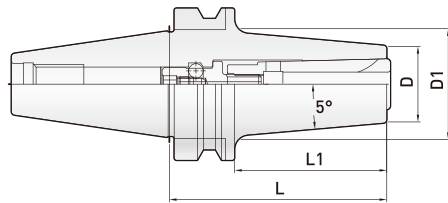

Taper tolerance
錐度公差



Surface roughness
表面粗度

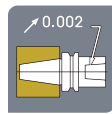

Run out accuracy
內孔偏擺度



Surface hardness
表面硬度

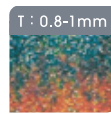

Carbonized depth
滲碳深度

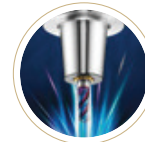
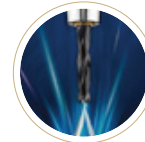

Order Code 訂購編號	L	L1	D	D1	Min-1G2.5 動態平衡	Spanner 扳手規格	Recommended Torsion 推薦鎖固扭力	Torque Wrench 扭力扳手	Center Coolant 中心出水	Side Coolant 側面出水	Pin Collet Pin筒夾
BT30-UC16-70	70	48	32	40	30,000	M6	15Nm	TW30+M06100	✓	✓	X
BT40-UC16-70	70	43	40	47	30,000	M6	15Nm	TW30+M06100	✓	✓	X
UC16-90	90	63	32	40	30,000	M6	15Nm	TW30+M06100	✓	✓	X
UC16-120	120	93	32	-	30,000	M6	15Nm	TW30+M06160	✓	✓	X
BT50-UC16-120	120	78	32	42	20,000	M6	15Nm	TW30+M06160	✓	✓	X
UC16-150	150	108	32	52	20,000	M6	15Nm	TW30+M06200	✓	✓	X

- Provide the center coolant and the side coolant.
- Select the side coolant must to use the collet with coolant slot, please check p.20
- Select the general collet for center coolant, please check p.19
- Coolant can be sprayed directly into the edge of tool for quick cooling and remove the steel chip.

- 可以選擇中心出水及側面出水的功能。
- 側面出水必須選用有水槽的夾頭，請參閱 p.20
- 中心出水選用一般的夾頭，請參閱 p.19
- 冷却液可直接噴到刀尖位置，可快速冷却及去除鐵屑。



UC GOLD CHUCK (UC20) High Vibration Damping Type

UC 黃金夾頭刀柄 (UC20) 高阻尼減震型

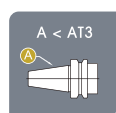
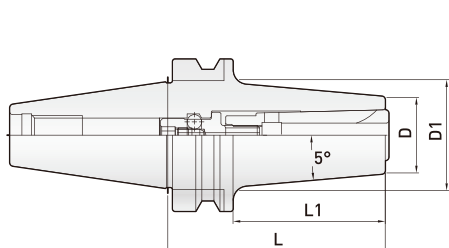

Taper tolerance
錐度公差

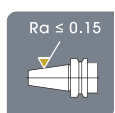

Surface roughness
表面粗度

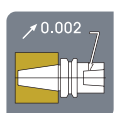

Run out accuracy
內孔偏擺度



Surface hardness
表面硬度

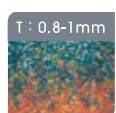

Carbonized depth
滲碳深度

Order Code 訂購編號	L	L1	D	D1	Min ⁻¹ G2.5 動態平衡	Spanner 扳手規格	Recommended Torsion 推薦鎖固扭力	Torque Wrench 扭力扳手	Center Coolant 中心出水	Side Coolant 側面出水	Pin Collet Pin筒夾
BT40-UC20-70	70	43	45	-	30,000	M8	20Nm	TW30+M08100	✓	✓	✓
BT50-UC20-100	100	62	45	58	20,000	M8	20Nm	TW30+M08160	✓	✓	✓
UC20-150	150	112	45	58	20,000	M8	20Nm	TW30+M08160	✓	✓	✓

- Provide the center coolant and the side coolant.
- Select the side coolant must to use the collet with coolant slot, please check p.20
- Select the general collet for center coolant, please check p.19
- Select the PIN Collet, please check p.21
- Coolant can be sprayed directly into the edge of tool for quick cooling and remove the steel chip.

- 可以選擇中心出水及側面出水的功能。
- 側面出水必須選用有水槽的夾頭，請參閱 p.20
- 中心出水選用一般的夾頭，請參閱 p.19
- 可以選用PIN Collet，請參閱 p.21
- 冷卻液可直接噴到刀尖位置，可快速冷卻及去除鐵屑。



UC PIN COLLET CHUCK (UC25) High Vibration Damping Type

UC 安卡夾頭 (UC25) 高阻尼減震型

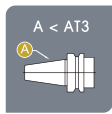
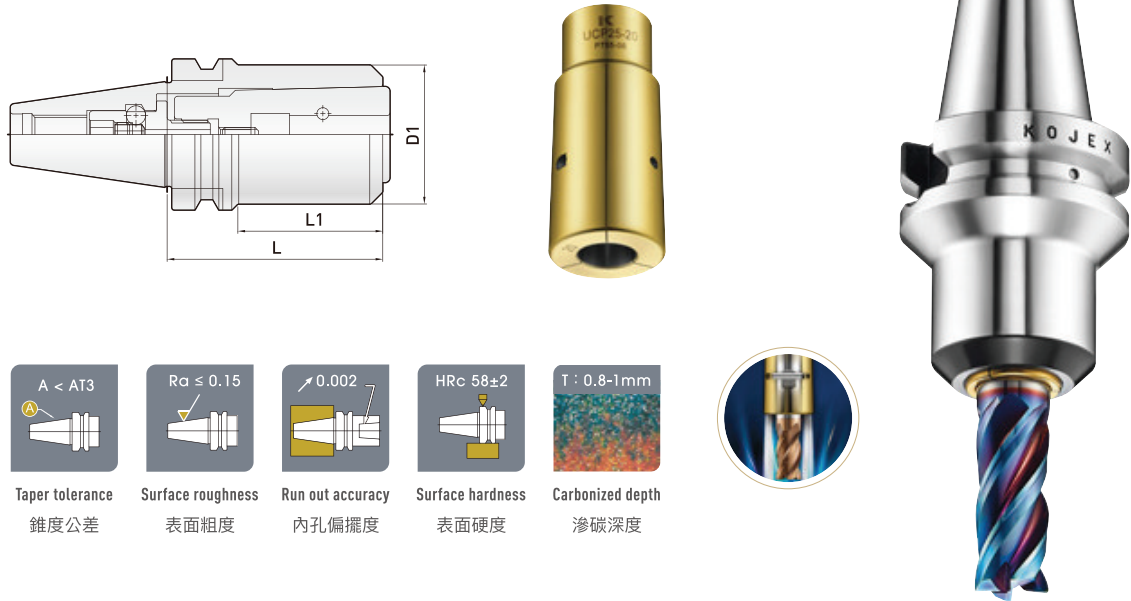

Taper tolerance
錐度公差



Surface roughness
表面粗度

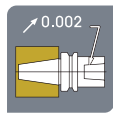

Run out accuracy
內孔偏擺度



Surface hardness
表面硬度

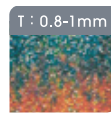

Carbonized depth
滲碳深度



Order Code 訂購編號	L	L1	D1	D2	Min ¹ G2.5 動態平衡	Spanner 扳手規格	Recommended Torsion 推薦鎖固扭力	Torque Wrench 扭力扳手
BT40-UC25-90	90	63	58	-	30,000	M10	25Nm	TW30+M10100
BT50-UC25-100	100	62	58	-	20,000	M10	25Nm	TW30+M10160
UC25-150	150	112	58	72	20,000	M10	25Nm	TW30+M10160

- The collet designed with PIN, 100% never tool pull out.
- Must be used R groove tool or standard specifications DIN 6535 HB for side lock tool.
- Must to choose the Pin collet, please check p.21
- 有PIN的夾頭設計，100%不掉刀。
- 必須使用R型溝槽刀具或標準規範DIN 6535 HB的側固刀具。
- 必須選用有PIN的筒夾，請參閱 p.21



— 側面出水 —
SIDE COOLANT

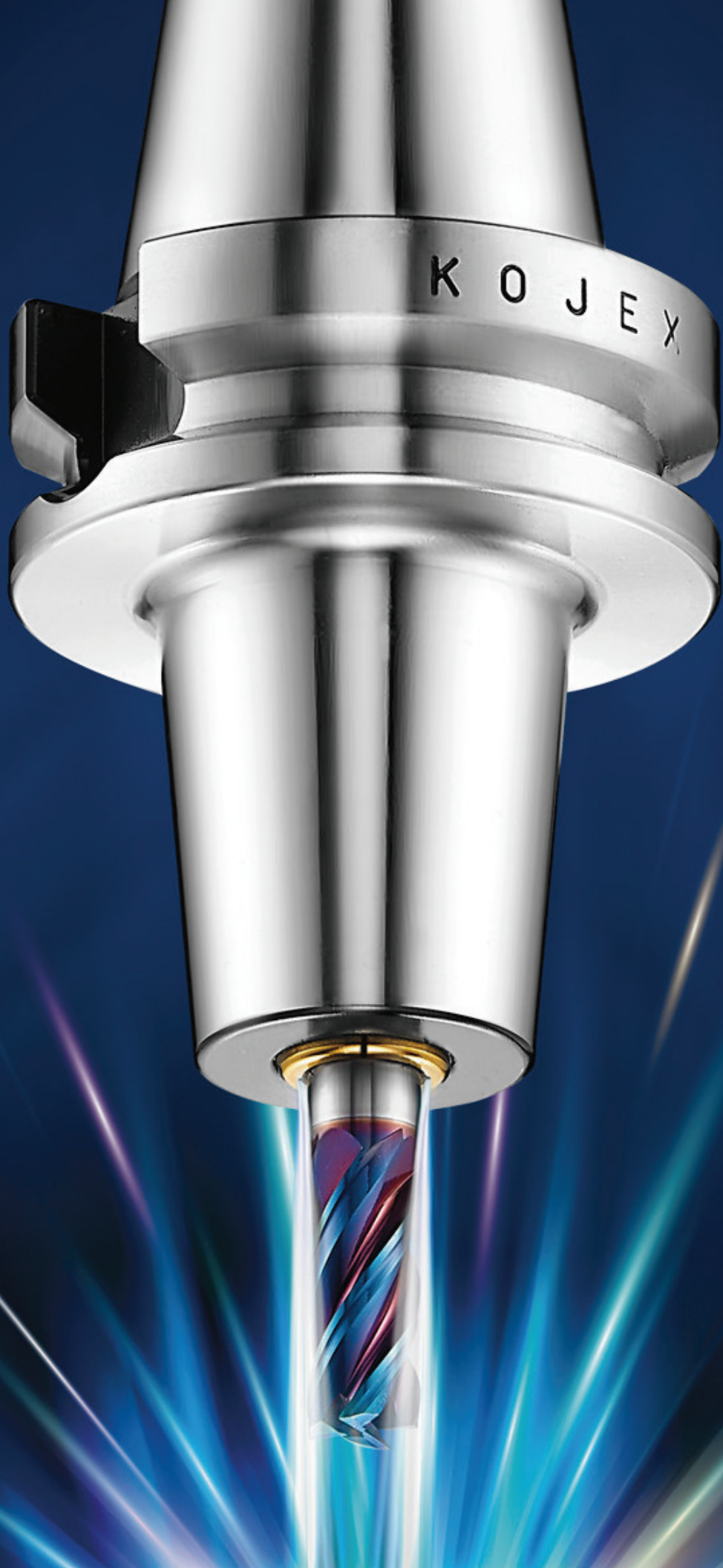

UC GOLD CHUCK (UC10) Slim Long Type

UC 黃金夾頭刀柄 (UC10) 小徑加長型

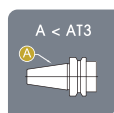
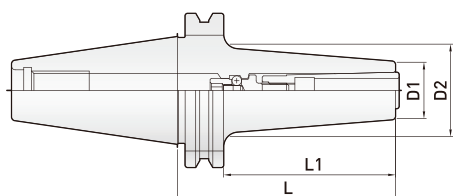

Taper tolerance
錐度公差

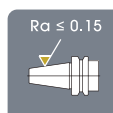

Surface roughness
表面粗度

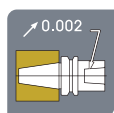

Run out accuracy
內孔偏擺度



Surface hardness
表面硬度

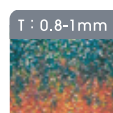

Carbonized depth
滲碳深度

Order Code 訂購編號	L	L1	D1	D2	Min ⁻¹ G6.3 動態平衡	Spanner 扳手規格	Recommended Torsion 推薦鎖固扭力	Fixed Torque Spanner 固定扭力扳手
SK40-UC10-90	90	71	24	36	20,000	M5	7Nm	30294-5154
UC10-120	120	101	24	41	20,000	M5	7Nm	30294-5156
UC10-150	150	131	24	47	20,000	M5	7Nm	30294-5156

- Collet chuck designed without nut and with inner-holding collet. This has strong rigidity and high stability.
- Torque wrench is recommended for chuck stability.
- Torque wrench must be ordered separately.
- The recommended torsion and correct torque wrench prevents deformation of the tool holder.

- 沒有螺帽的後拉式夾頭設計，鋼性強穩定性高。
- 為求使用上的穩定性，建議使用扭力扳手。
- 扭力扳手必須另外訂購。
- 鎖固扭力不要超過推薦值的30%以上，過高的鎖固扭力，可能導致刀柄的變形。



UC GOLD CHUCK (UC16) High Vibration Damping Type

UC 黃金夾頭刀柄 (UC16) 高阻尼減震型

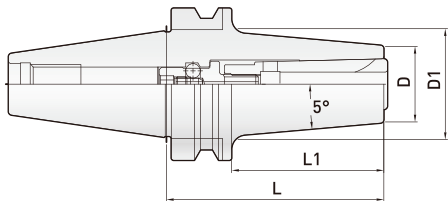

Taper tolerance 錐度公差	Surface roughness 表面粗度	Run out accuracy 內孔偏擺度	Surface hardness 表面硬度	Carbonized depth 滲碳深度

Order Code 訂購編號	L	L1	D	D1	Min ⁻¹ G6.3 動態平衡	Spanner 扳手規格	Recommended Torsion 推薦鎖固扭力	Torque Wrench 扭力扳手	Center Coolant 中心出水	Side Coolant 側面出水	Pin Collet Pin筒夾
SK40-UC16-90	90	71	32	40	20,000	M6	15Nm	TW30+M06100	✓	✓	X

- Provide the center coolant and the side coolant.
- Select the side coolant must use the collet with coolant slot, please check p.20
- Select the general collet for center coolant, please check p.19
- Coolant can be sprayed directly into the edge of tool for quick cooling and remove the steel chip.
- 可以選擇中心出水及側面出水的功能。
- 側面出水必須選用有水槽的夾頭，請參閱 p.20
- 中心出水選用一般的夾頭，請參閱 p.19
- 冷却液可直接噴到刀尖位置，可快速冷却及去除鐵屑。



UC GOLD CHUCK (UC20) High Vibration Damping Type

UC 黃金夾頭刀柄 (UC20) 高阻尼減震型

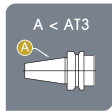
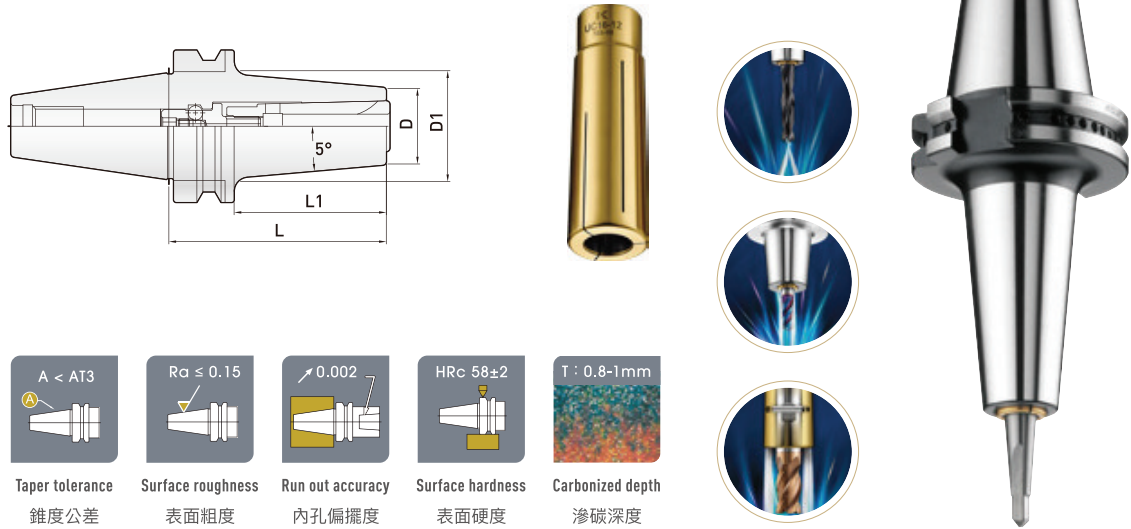

$A < AT3$

Taper tolerance
錐度公差



$Ra \leq 0.15$

Surface roughness
表面粗度

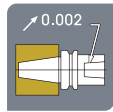

$\nabla 0.002$

Run out accuracy
內孔偏擺度



HRC 58±2

Surface hardness
表面硬度

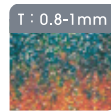

T: 0.8-1mm

Carbonized depth
滲碳深度

Order Code 訂購編號	L	L1	D	D1	Min ⁻¹ G6.3 動態平衡	Spanner 扳手規格	Recommended Torsion 推薦鎖固扭力	Torque Wrench 扭力扳手	Center Coolant 中心出水	Side Coolant 側面出水	Pin Collet Pin筒夾
SK40-UC20-70	70	43	45	-	20,000	M8	20Nm	TW30+M08100	✓	✓	✓

- Provide the center coolant and the side coolant.
- Select the side coolant must use the collet with coolant slot, please check p.20
- Select the general collet for center coolant, please check p.19
- Select the PIN Collet, please check p.21
- Coolant can be sprayed directly into the edge of tool for quick cooling and remove the steel chip.

- 可以選擇中心出水及側面出水的功能。
- 側面出水必須選用有水槽的夾頭，請參閱 p.20
- 中心出水選用一般的夾頭，請參閱 p.19
- 可以選用PIN Collet，請參閱 p.21
- 冷卻液可直接噴到刀尖位置，可快速冷卻及去除鐵屑。



PIN COLLET COOLANT

— 安卡夾頭 —

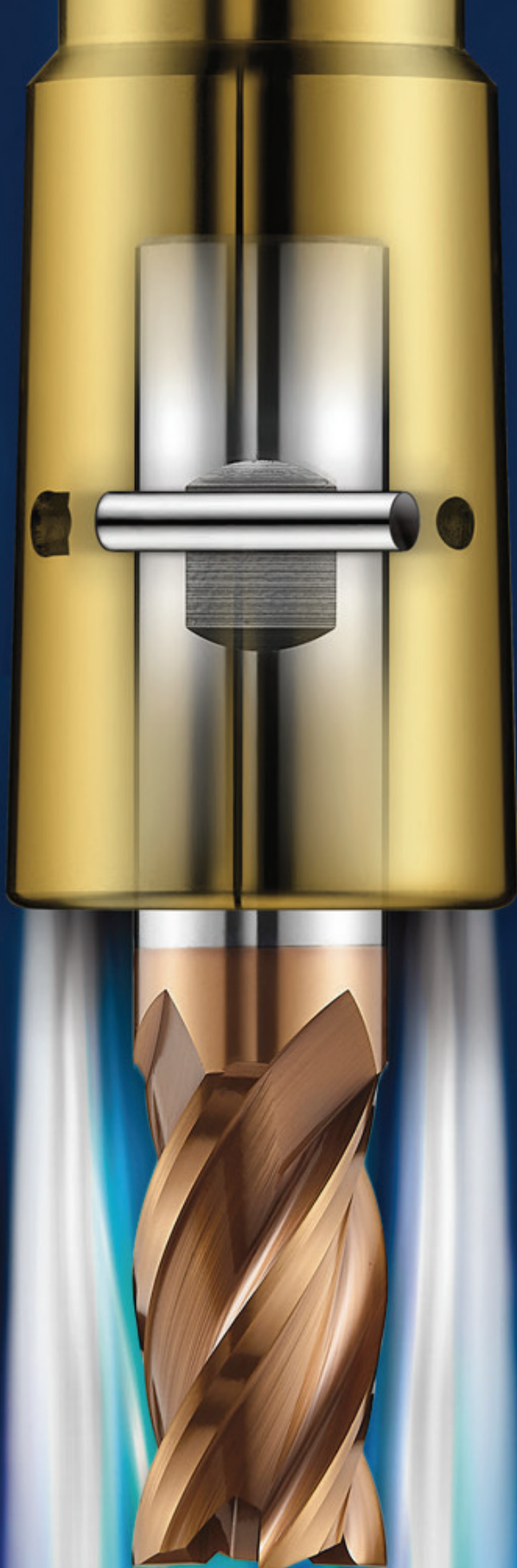

UC COLLET

UC 黃金夾頭

- Runout <math>< 5\mu\text{m}</math> (4×D)
- 跳動精度 <math>< 5\mu\text{m}</math> (4×D)

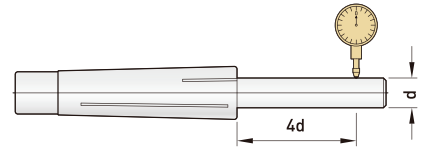

UC 6

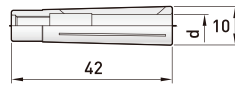

Order Code 訂購編號	(d) 夾持徑
UC6-3	3
4	4
5	5
6	6



UC 10

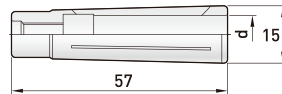

Order Code 訂購編號	(d) 夾持徑
UC10-3	3
4	4
5	5
6	6
8	8
10	10



UC 16 Center Coolant (中心出水)

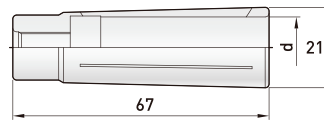

Order Code 訂購編號	(d) 夾持徑
UC16-6	6
8	8
10	10
12	12
14	14
16	16



UC 20 Center Coolant (中心出水)

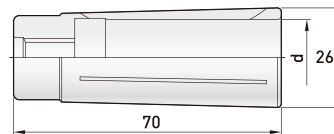

Order Code 訂購編號	(d) 夾持徑
UC20-6	6
8	8
10	10
12	12
16	16
20	20

UC COLLET (Side Coolant)

UC 黃金夾頭 (側邊出水)

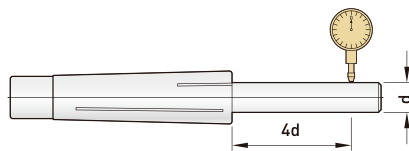

- Runout <math>< 5\mu\text{m}</math> ($4 \times D$)
- 跳動精度 <math>< 5\mu\text{m}</math> ($4 \times D$)

- Coolant can be sprayed directly into the edge of tool, for quick cooling and remove the steel chip.
- 冷却液可直接噴到刀尖位置，可快速冷却及去除鐵屑。

UC 16F / UC 20F

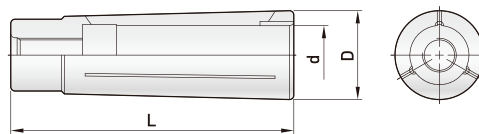

Order Code 訂購編號	(d) 夾持徑	L	D
UC16- 6F	6	67	21
8F	8		
10F	10		
12F	12		
14F	14		
16F	16		
UC20- 6F	6	70	26
8F	8		
10F	10		
12F	12		
16F	16		
20F	20		

UC PIN COLLET

UC 安卡夾頭

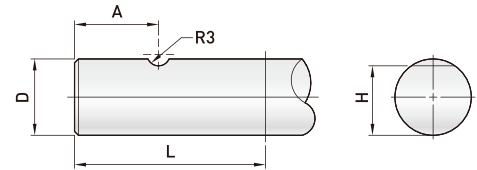
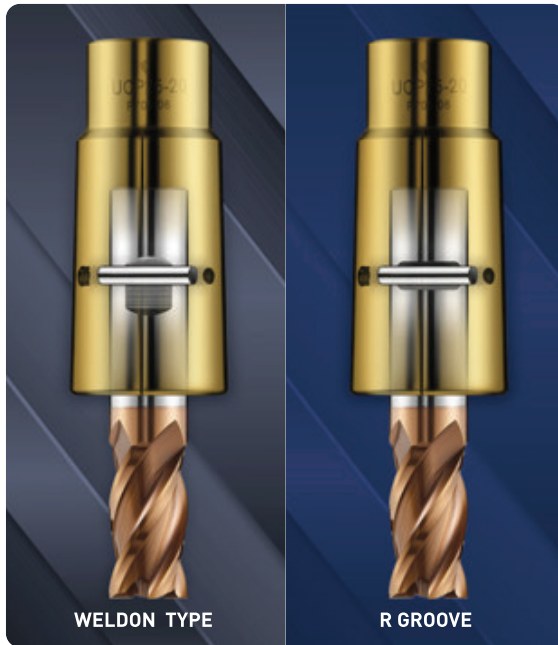

Tool shark Dia.				
D mm	L mm	A mm	H mm	R groove R 型溝槽
6	36	17 ± 2	4.8 ⁰ _{-0.4}	R3
8	40	17 ± 2	6.6 ⁰ _{-0.4}	
10	40	19 ± 2	8.4 ⁰ _{-0.4}	
12	45	21 ± 2	10.4 ⁰ _{-0.4}	
16	48	21 ± 2	14.2 ⁰ _{-0.4}	
20	50	22 ± 2	18.2 ⁰ _{-0.4}	
25	56	29 ± 2	23 ⁰ _{-0.4}	

- Provide the Pin collet for UC20 and UC25. The tools can choose the standard side lock tool (DIN6535HB) or grinded the R groove at tools.
- UC PIN夾頭有UC20及UC25兩個系列可以選擇，刀具必須自行在柄部研磨R型溝槽或者選用標準側固的刀柄 (DIN6535HB)。

UC 20P / UC 25P

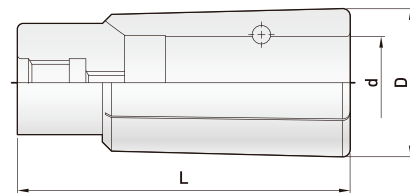
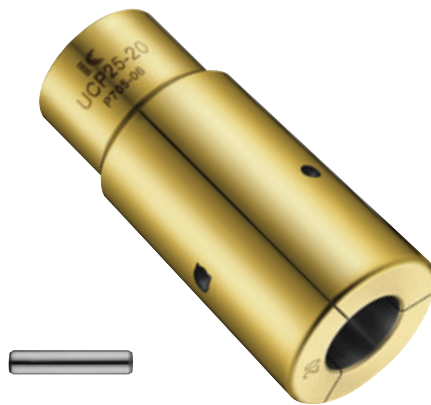

Order Code 訂購編號	(d) 夾持徑	L	D
UC20- 6P	6	70	26
8P	8		
10P	10		
12P	12		
16P	16		
UC25- 12P	12	90	40
16P	16		
20P	20		
25P	25		

FIXED TORQUE SPANNER

固定扭力扳手



Order Code 訂購編號	Torque 扭力值	⊙	L	Tool Item 適用規格
30294-5144	5Nm	4	70	UC6
5146	5Nm	4	115	
5152	7Nm	5	55	UC10
5154	7Nm	5	90	
5156	7Nm	5	140	
5158	7Nm	5	180	
5159	7Nm	5	240	

TORQUE WRENCH

扭力扳手



Order Code 訂購編號	Torque Nm 扭力值	Square Drive 接頭	Length (mm) 長度
TW30	5-30	3 / 8"	300



Order Code 訂購編號	⊙	Length (mm)	Tool Item 適用規格
M06100	6	100	UC16
M06160	6	160	UC16
M06200	6	200	UC16
M08100	8	100	UC20
M08160	8	160	UC20
M10100	10	100	UC25
M10160	10	160	UC25

DC

KOJEX IS THE INITIATOR
OF INNER-HOLDING
COLLET CHUCKS

—
廣傑公司是
後拉式夾頭的創始者





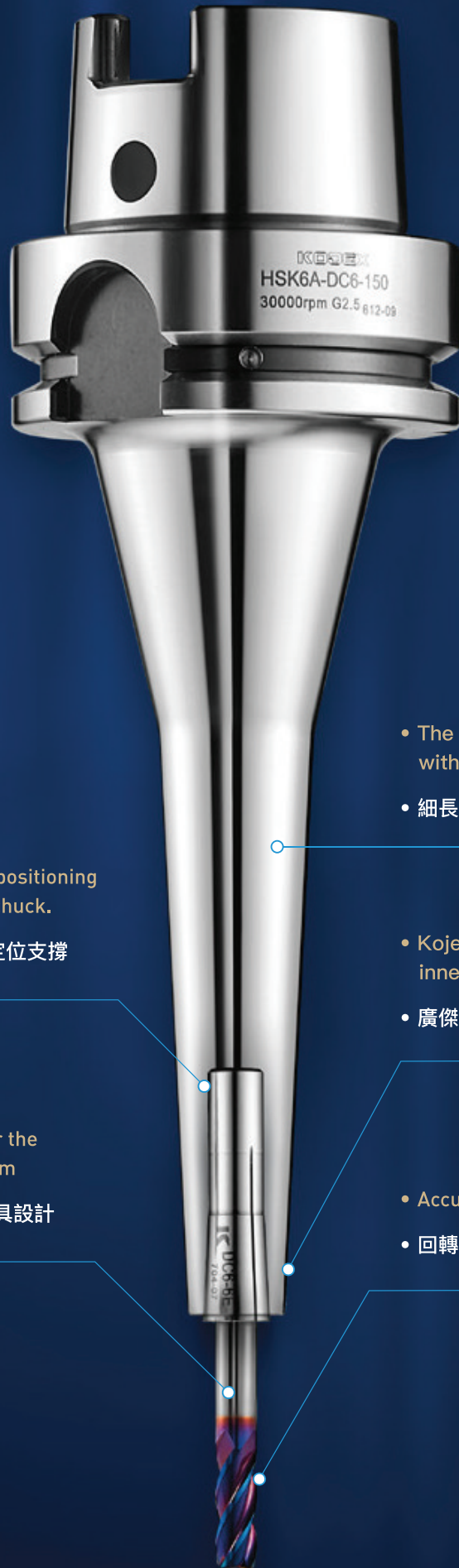

- The end of collet has positioning support in the collet chuck.

- 筒夾後端在本體內有定位支撐

- Specially designed for the small tools under 6mm

- 針對6mm以下的小刀具設計

- The slim chuck is designed with excellent dodge.

- 細長柄設計具有極佳的閃避性

- Kojex is the initiator of inner-holding collet chuck.

- 廣傑獨創沒有螺帽的筒夾設計

- Accuracy < 0.005mm (4XD)

- 回轉精度在0.005mm以下 (4XD)

RUN OUT

Accuracy within 0.005mm at 4 times length of cutter edge to ensure uniform an even cutting action, increasing cutting speed and tool life.

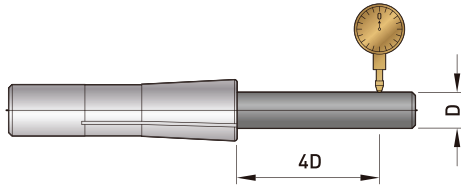

回轉精度

4倍刃長精度在0.005mm以內，確保切削時每刃刀口的均勻切削，可使切削速度提高及刀具壽命增加。

THE END OF COLLET HAS POSITIONING SUPPORT IN THE COLLET CHUCK.

Kojex's well-designed to reduce vibration during the milling cutter processing.

筒夾後端在本體內有定位支撐

這是KOJEX的精心設計，可以減少銑刀加工時的震動。

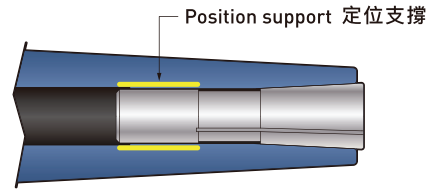

EXCELLENT DODGE

The design of the slim chuck support sufficient length. The five-axis machining or mold processing are very suitable.

極佳的閃避性

細長柄的設計，充足的長度規格。無論是五軸加工機或模具加工均非常適用。



SPECIALLY FOR END MILL

This is a one-to-one special collet, 95% taper area of the collet [K] is covered the collet chuck, during the milling process to achieve excellent vibration damping effect.

銑刀專用的筒夾可供選擇

這是一對一的專用筒夾，筒夾的斜面95%面積[K]，可與本體貼合，銑刀加工時，具有極佳的阻尼減震效果。

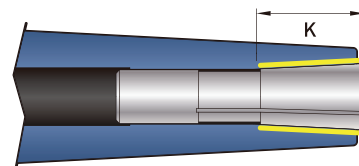

KOJEX IS THE INITIATOR OF INNER-HOLDING COLLET CHUCKS

The simple structure can reduce interference and more stable when the cutting processing.

廣傑獨創

沒有螺帽的筒夾設計

沒有螺帽的筒夾設計，結構簡單減少干涉，切削時更為安定。



SPECIALLY DESIGNED FOR THE SMALL TOOLS UNDER 6MM

The clamping range from 1mm to 6mm for choice any type tools, there are 33 size collet for choice.

針對6mm

以下的小刀具設計

可夾持1mm~6mm的任何刀具，共有33個筒夾規格可供選擇。



DC SLIM CHUCK

DC 小徑夾頭刀柄

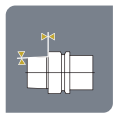
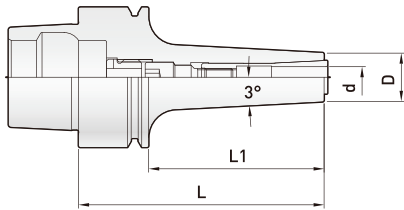
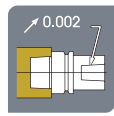
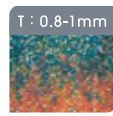
Dual face contact
兩面接觸Surface roughness
表面粗度Run out accuracy
內孔偏擺度Surface hardness
表面硬度Carbonized depth
滲碳深度

Order Code 訂購編號	Range(d) 夾持範圍	L	L1	D	Min ⁺ G2.5 動態平衡	Spanner 扳手規格	Recommended Torsion 推薦鎖固扭力	Fixed Torque Spanner 固定扭力扳手
HSK32E-DC6-70	1~6	70	50	14	42,000	M4	5Nm	30294-5144
HSK40E-DC6-70	1~6	70	50	14	42,000	M4	5Nm	30294-5144
HSK50E-DC6-75	1~6	75	49	14	36,000	M4	5Nm	30294-5144

- The tool shank under 2mm must to use 3Nm torque wrench.
- Collet chuck designed without nut and with inner-holding collet. This has strong rigidity and high stability.
- Torque wrench is recommended for chuck stability.
- Torque wrench must be ordered separately.
- The recommended torsion and correct torque wrench prevents deformation of the tool holder.

- 刀具柄徑在 $\varnothing 2$ 以下，必須使用3Nm的扭力扳手。
- 沒有螺帽的後拉式夾頭設計，鋼性強穩定性高。
- 為求使用上的穩定性，建議使用扭力扳手。
- 扭力扳手必須另外訂購。
- 鎖固扭力不要超過推薦值的30%以上，過高的鎖固扭力，可能導致刀柄的變形。



DC SLIM CHUCK

DC 小徑夾頭刀柄

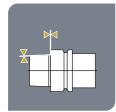
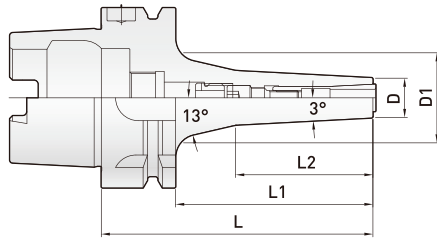

Dual face contact
兩面接觸



Surface roughness
表面粗度

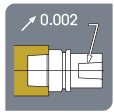

Run out accuracy
內孔偏擺度



Surface hardness
表面硬度

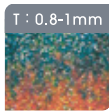

Carbonized depth
滲碳深度

Order Code 訂購編號	Range(d) 夾持範圍	L	L1	L2	D	Min ⁻¹ G2.5 動態平衡	Spanner 扳手規格	Recommended Torsion 推薦鎖固扭力	Fixed Torque Spanner 固定扭力扳手
HSK63A-DC6-95	1~6	95	69	45	14	30,000	M4	5Nm	30294-5144
DC6-120	1~6	120	94	65	14	30,000	M4	5Nm	30294-5146
DC6-150	1~6	150	124	82	14	30,000	M4	5Nm	30294-5146

- The tool shank under 2mm must to use 3Nm torque wrench.
- Collet chuck designed without nut and with inner-holding collet. This has strong rigidity and high stability.
- Torque wrench is recommended for chuck stability.
- Torque wrench must be ordered separately.
- The recommended torsion and correct torque wrench prevents deformation of the tool holder.

- 刀具柄徑在 $\varnothing 2$ 以下，必須使用3Nm的扭力扳手。
- 沒有螺帽的後拉式夾頭設計，鋼性強穩定性高。
- 為求使用上的穩定性，建議使用扭力扳手。
- 扭力扳手必須另外訂購。
- 鎖固扭力不要超過推薦值的30%以上，過高的鎖固扭力，可能導致刀柄的變形。



DC

HSK

A63

DC SLIM CHUCK

DC 小徑夾頭刀柄

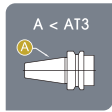
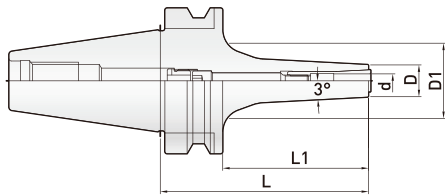

Taper tolerance
錐度公差



Surface roughness
表面粗度

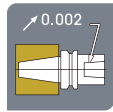

Run out accuracy
內孔偏擺度



Surface hardness
表面硬度

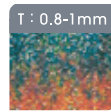

Carbonized depth
滲碳深度

Order Code 訂購編號	Range(d) 夾持範圍	L	L1	D	D1	Min ⁻¹ G2.5 動態平衡	Spanner 扳手規格	Recommended Torsion 推薦鎖固扭力	Fixed Torque Spanner 固定扭力扳手
BT30-DC6-60	1~6	60	38	14	-	30,000	M4	5Nm	30294-5144
DC6-90	1~6	90	68	14	28	30,000	M4	5Nm	30294-5144
DC6-120	1~6	120	98	14	38	30,000	M4	5Nm	30294-5144
BT40-DC6-90	1~6	90	63	14	26	30,000	M4	5Nm	30294-5146
DC6-120	1~6	120	93	14	32	30,000	M4	5Nm	30294-5146
DC6-150	1~6	150	123	14	41	30,000	M4	5Nm	30294-5146

- The tool shank under 2mm must to use 3Nm torque wrench.
- Collet chuck designed without nut and with inner-holding collet. This has strong rigidity and high stability.
- Torque wrench is recommended for chuck stability.
- Torque wrench must be ordered separately.
- The recommended torsion and correct torque wrench prevents deformation of the tool holder.

- 刀具柄徑在 $\varnothing 2$ 以下，必須使用3Nm的扭力扳手。
- 沒有螺帽的後拉式夾頭設計，鋼性強穩定性高。
- 為求使用上的穩定性，建議使用扭力扳手。
- 扭力扳手必須另外訂購。
- 鎖固扭力不要超過推薦值的30%以上，過高的鎖固扭力，可能導致刀柄的變形。



DC SLIM CHUCK

DC 小徑夾頭刀柄

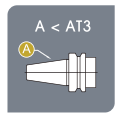
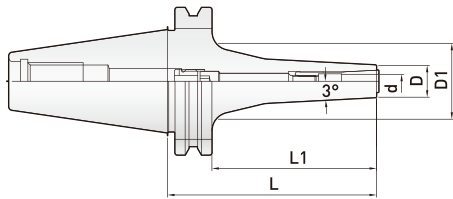

Taper tolerance
錐度公差



Surface roughness
表面粗度

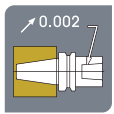

Run out accuracy
內孔擺度



Surface hardness
表面硬度

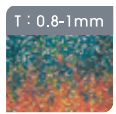

Carbonized depth
滲碳深度

Order Code 訂購編號	Range(d) 夾持範圍	L	L1	D	D1	Min ⁻¹ G6.3 動態平衡	Spanner 扳手規格	Recommended Torsion 推薦鎖固扭力	Fixed Torque Spanner 固定扭力扳手
SK40-DC6-90	1~6	90	71	14	30	20,000	M4	5Nm	30294-5146
DC6-120	1~6	120	101	14	40	20,000	M4	5Nm	30294-5144
DC6-150	1~6	150	131	14	42	20,000	M4	5Nm	30294-5146

- The tool shank under 2mm must to use 3Nm torque wrench.
- Collet chuck designed without nut and with inner-holding collet. This has strong rigidity and high stability.
- Torque wrench is recommended for chuck stability.
- Torque wrench must be ordered separately.
- The recommended torsion and correct torque wrench prevents deformation of the tool holder.

- 刀具柄徑在 $\varnothing 2$ 以下，必須使用3Nm的扭力扳手。
- 沒有螺帽的後拉式夾頭設計，鋼性強穩定性高。
- 為求使用上的穩定性，建議使用扭力扳手。
- 扭力扳手必須另外訂購。
- 鎖固扭力不要超過推薦值的30%以上，過高的鎖固扭力，可能導致刀柄的變形。



DC EXTENSION SLIM CHUCK

DC 直柄式延長桿

Fig 1 / 圖號 1

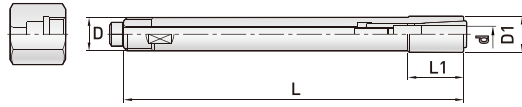
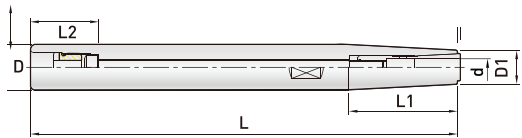

Fig 2 / 圖號 2



Order Code 訂購編號	d	L	L1	L2	D	D1	Fig 圖號	Stop Nut 止動螺帽	Spanner 扳手規格	Recommended Torsion 推薦鎖固扭力	Collet 筒夾
ST10-DC4-90	2-4	90	14	--	10	9	1	TP-M8	30194-632(M3)	4Nm	DC4
ST12-DC4-120	2-4	120	38	--	12	9	2	--	30194-632(M3)	4Nm	DC4
ST12-DC6-120	1-6	120	40	--	12	14	1	TP-M12	30194-643(M4)	5Nm	DC6
ST16-DC6-150	1-6	150	35	24	16	14	2	--	30194-643(M4)	5Nm	DC6
ST20-DC6-200	1-6	200	70	74	20	14	2	--	30194-643(M4)	5Nm	DC6
ST25-DC6-250	1-6	250	115	124	25	14	2	--	30194-644(M4)	5Nm	DC6

- The tool shank under 2mm must use 3Nm torque wrench.
- Extension adaptor includes one hexagon spanner and spanner(A).

- 刀具柄徑在 $\phi 2$ 以下，必須使用3Nm的扭力扳手。
- 出貨時附T型扳手及扳手(A)各1支。



SD13 EXTENSION SLIM CHUCK

SD13 筒夾式延長桿

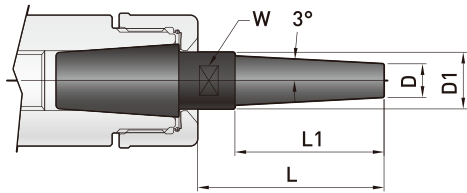

Order Code 訂購編號	Holder 本體規格	Range(d) 夾持範圍	L	L1	D	D1	Spanner 扳手	W	Collet 筒夾
SD13-DC4-50	SD13	2~4	50	40	9	15	30194-632	13mm	DC4
SD13-DC6-50	SD13	1~6	50	40	14	15	30194-643	13mm	DC6

- The tool shank under 2mm must use 3Nm torque wrench.
- The users can more choose for the extension rod of SD13 collet chuck.
- Extension adaptor includes one hexagon spanner and spanner(A).
- 刀具柄徑在 $\phi 2$ 以下，必須使用3Nm的扭力扳手。
- 配合SD13本體的延長桿，使用者可以多一種選擇。
- 出貨時附T型扳手及扳手(A)各1支。



ER EXTENSION SLIM CHUCK

ER 筒夾式延長桿

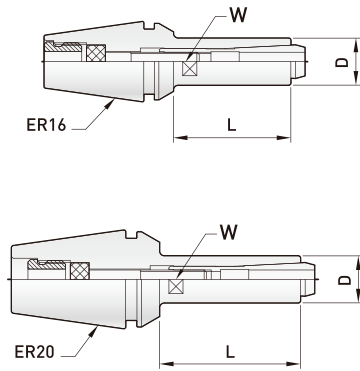

Order Code 訂購編號	Holder 本體規格	Range(d) 夾持範圍	L	D	Spanner 扳手	W	Collet 筒夾
ER16-DC4-25	ER16	2~4	25	9	30194-632	8	DC4
ER20-DC6-35	ER20	1~6	35	14	30194-643	13	DC6

- The tool shank under 2mm must use 3Nm torque wrench.
- The users can more choose for the extension rod of ER collet chuck.
- Extension adaptor includes one hexagon spanner and spanner(A).
- 刀具柄徑在 $\varnothing 2$ 以下，必須使用3Nm的扭力板手。
- 配合ER本體的延長桿，使用者可以多一種選擇。
- 出貨時附T型扳手及扳手(A)各1支。





SET OF DC EXTENSION SLIM CHUCK



DC 小徑延長桿 (整組)



DC4

Order Code 訂購編號	Contains 內容			
	Collet Chuck 夾頭	Collet 筒夾	Spanner (A) 扳手 	Spanner (B) 扳手 
SST10-DC4-90	ST10-DC4-90	DC4-2E x 1pc DC4-3E x 1pc	30194-002	30194-632(M3)
SST12-DC4-120	ST12-DC4-120	DC4-4E x 1pc		

DC6

Order Code 訂購編號	Contains 內容			
	Collet Chuck 夾頭	Collet 筒夾	Spanner (A) 扳手 	Spanner (B) 扳手 
SST12-DC6-120	ST12-DC6-120	DC6-3E x 1pc DC6-4E x 1pc	30194-002	30194-643(M4)
SST16-DC6-150	ST16-DC6-150	DC6-6E x 1pc		30194-643(M4)



DC COLLET (E TYPE)

DC 筒夾 (E型)

DC COLLET RUNOUT

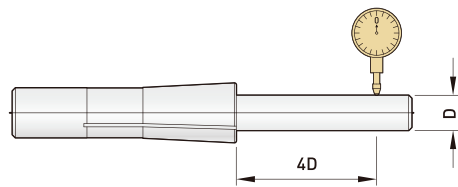

- Runout <math>< 5\mu\text{m}</math> (4×D)
- 跳動精度 <math>< 5\mu\text{m}</math> (4×D)

- The design of E Type collets is emphasized on increase the clamping force of end mills.
- Special designed for end mill.
- E Type筒夾設計重點是強調立銑刀的夾持力。
- 立銑刀專用夾頭。

DC 4 COLLET

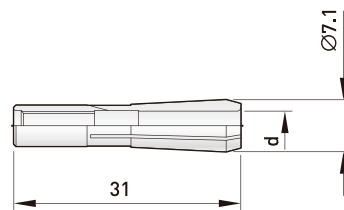

Order Code 訂購編號	(d) 夾持徑
DC4-2E	2
3E	3
4E	4
1/8E	3.175

DC 6 COLLET

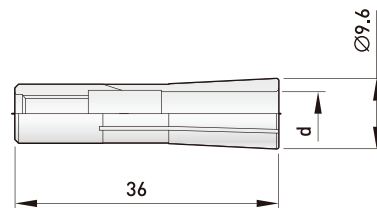

Order Code 訂購編號	(d) 夾持徑
DC6-3E	3
4E	4
5E	5
6E	6
1/8E	3.175
1/4E	6.35

DC6 COLLET (K TYPE) for small shank

DC6 筒夾 (K型) 微小徑專用

DC COLLET RUNOUT

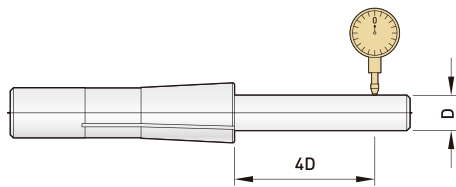

- Runout <math>< 5\mu\text{m}</math> (4×D)
- 跳動精度 <math>< 5\mu\text{m}</math> (4×D)

- K Type collets can clamp any type of drills, reamers and taps below $\varnothing 1.9\text{mm}$.
- Gripping range of each type of collets is 0.1mm.
- K Type筒夾，可夾持 $\varnothing 1.9\text{mm}$ 以下的鑽頭、鉸刀、絲攻及銑刀。
- 每一個筒夾的夾持範圍為0.1mm。

DC 6 COLLET FOR SMALL SHANK

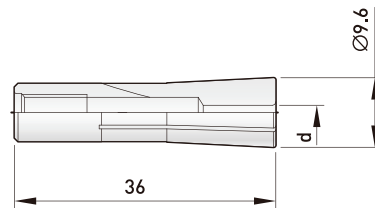

Order Code 訂購編號	d	(d) 夾持徑
DC6-1.0K	1.0	0.9~1.0
1.1K	1.1	1.0~1.1
1.2K	1.2	1.1~1.2
1.3K	1.3	1.2~1.3
1.4K	1.4	1.3~1.4
1.5K	1.5	1.4~1.5
1.6K	1.6	1.5~1.6
1.7K	1.7	1.6~1.7
1.8K	1.8	1.7~1.8
1.9K	1.9	1.8~1.9

DC6 COLLET (D TYPE)

DC6 筒夾 (D型)

DC COLLET RUNOUT

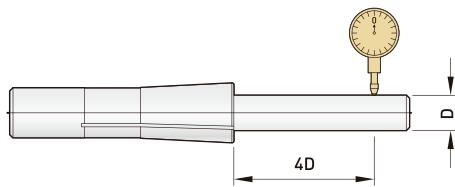

- Runout <math>< 5\mu\text{m}</math> (4×D)
- 跳動精度 <math>< 5\mu\text{m}</math> (4×D)

- D Type collets can clamp any type of drills, reamers and taps below $\varnothing 6\text{mm}$.
- Gripping range of each type of collets is 0.25mm.
- D Type筒夾，可夾持 $\varnothing 6\text{mm}$ 以下的鑽頭、鉸刀、絲攻及銑刀。
- 每一個筒夾的夾持範圍為0.25mm。

DC 6-D COLLET

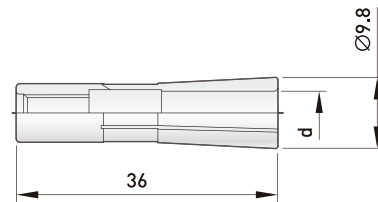

Order Code 訂購編號	d	(d) 夾持徑
DC6-2D	2	1.75~2.00
2.25D	2.25	2.00~2.25
2.5D	2.5	2.25~2.50
2.75D	2.75	2.50~2.75
3D	3	2.75~3.00
3.25D	3.25	3.00~3.25
3.5D	3.5	3.25~3.50
3.75D	3.75	3.50~3.75
4D	4	3.75~4.00
4.25D	4.25	4.00~4.25
4.5D	4.5	4.25~4.50
4.75D	4.75	4.50~4.75
5D	5	4.75~5.00
5.25D	5.25	5.00~5.25
5.5D	5.5	5.25~5.50
5.75D	5.75	5.50~5.75
6D	6	5.75~6.00

SPANNER

扳手



Order Code 訂購編號		L
30194-632	3	100
643	4	150
644	4	200

FIXED TORQUE SPANNER

固定扭力扳手



Order Code 訂購編號	Torque 扭力值		L	Tool Size 適用規格
30294-5134	3Nm	4	70	Collet under 2mm
5144	5Nm	4	70	DC6
5146	5Nm	4	115	



Order Code 訂購編號
30194-002

HEC

INCREASING TOOL
EFFICIENCY STARTS FROM
THE CHUCK

提升刀具效率從夾頭開始





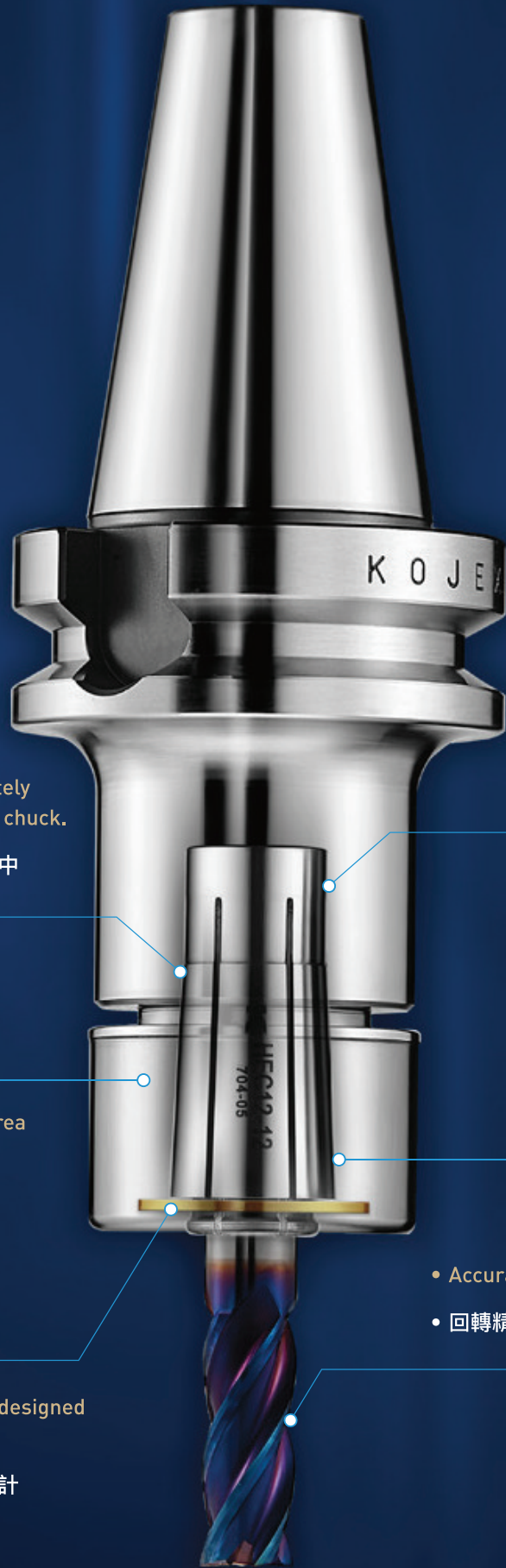

- The collet is completely covered in the collet chuck.

- 筒夾完全包覆在本體中

- Maximum locking area of screw teeth.

- 螺牙鎖固面積極大化

- The clamping nut is designed with flat bearing.

- 螺帽有軸承墊片的設計

- The end of collet has positioning support in the collet chuck.

- 筒夾後端在本體內有定位支撐

- The collet is designed with the small angle (Designed specifically for milling).

- 小角度的後拉式筒夾設計 (專門為銑刀設計)

- Accuracy < 0.005mm (4XD)

- 回轉精度在0.005mm以下 (4XD)

RUN OUT

Accuracy within 0.005mm at 4 times length of cutter edge to ensure uniform an even cutting action, increasing cutting speed and tool life.

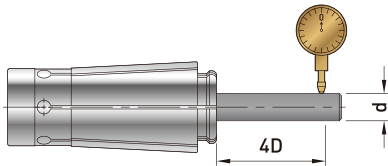

回轉精度

4倍刃長精度在0.005mm以內，確保切削時每刃刀口的均勻切削，可使切削速度提高及刀具壽命增加。

COLLETS SPECIALLY DESIGNED FOR MILLING

The design of the small angle collet can increase the clamping force of the tool and milling is more stable during the processing.

專門為銑刀設計的筒夾

小角度筒夾的設計，可增加刀具的夾持力，銑刀在加工時，更為安定。

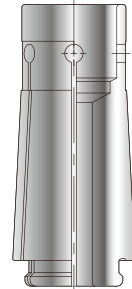

THE END OF COLLET HAS POSITIONING SUPPORT IN THE COLLET CHUCK.

Kojex's well-designed to reduce vibration during the milling cutter processing.

筒夾後端在本體 內有定位支撐

這是KOJEX的精心設計，可以減少銑刀加工時的震動。

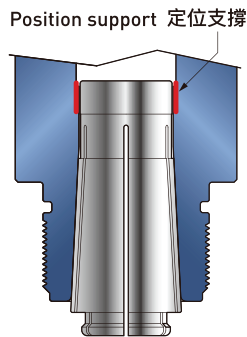

THE CLAMPING NUT IS DESIGNED WITH FLAT BEARING

The bearing nut can increase the clamping force more than 30% and avoid the distortion and deformation of the collet.

螺帽有軸承墊片 的設計

可以增加30%以上的鎖固力量及避免筒夾的扭曲變形。

Flat bearing 軸承墊片

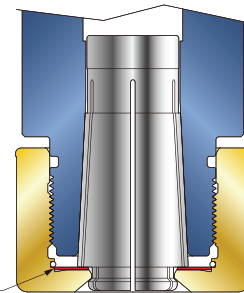

THE COLLET IS COMPLETELY COVERED IN THE COLLET CHUCK

95% taper area of the collet [K] is covered the collet chuck during the milling processing to arrive excellent vibration damping of performance.

筒夾可完全包覆 在本體內

筒夾的斜面95%面積 [K]可與本體貼合，銑刀加工時，具有極佳的阻尼減震的效果。

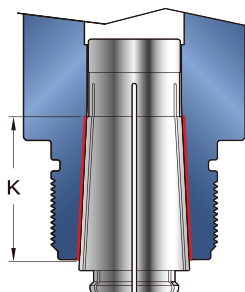

MAXIMUM LOCKING AREA OF SCREW TEETH [T]

The maximum locking area of the screw teeth can increase stability and avoid cutting vibration caused by the nut loosening.

螺牙鎖固面積 [T] 極大化

可使刀具的鎖固更為安定，避免因切削震動而產生螺帽鬆動。

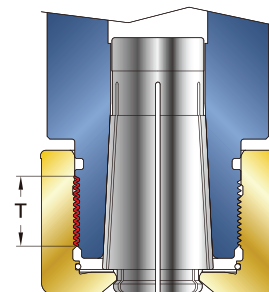

HEC MILLING CHUCK (AM TYPE)

HEC 精銑夾頭刀柄 (AM型)

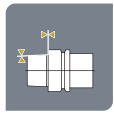
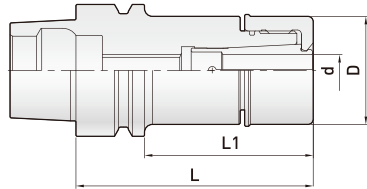

Dual face contact
兩面接觸



Surface roughness
表面粗度

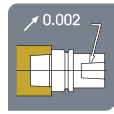

Run out accuracy
內孔偏擺度



Surface hardness
表面硬度

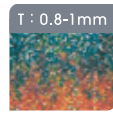

Carbonized depth
滲碳深度

Order Code 訂購編號	Range(d) 夾持範圍	L	L1	D	Min ⁻¹ G2.5 動態平衡	Nut 螺帽	Spanner 扳手
HSK40E-HEC8-70AM	3-8	70	50	30	42,000	CN-HEC8AM	30194-830
HEC12-75AM	4-12	75	55	42	42,000	CN-HEC12AM	30194-842
HSK50E-HEC8-70AM	3-8	70	44	30	36,000	CN-HEC8AM	30194-830
HEC12-70AM	4-12	70	44	42	36,000	CN-HEC12AM	30194-842

- The circular nuts can be replaced with the hexagonal nuts.
- Clamping nut design by circular cylinder. Bearing spanner must be used.
- End mill chuck specially designed for hard cutting material.
- Superior surface finish for mold tools and 3-D work.
- Bearing spanner and stop screw must be ordered separately.

- 全圓螺帽可以換成六角螺帽。
- 全圓螺帽，必須使用軸承扳手。
- 專門為難切削材設計的銑刀夾頭。
- 在模具加工時，表面光滑度極佳。
- 軸承扳手及止動螺絲必須另外訂購。



HEC MILLING CHUCK (AM TYPE)

HEC 精銑夾頭刀柄 (AM型)

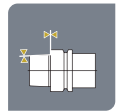
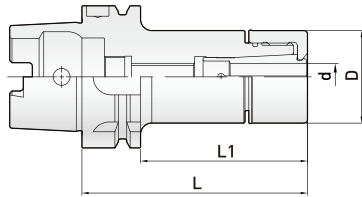

Dual face contact
兩面接觸



Surface roughness
表面粗度

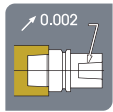

Run out accuracy
內孔偏擺度



Surface hardness
表面硬度

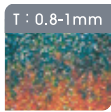

Carbonized depth
滲碳深度

Order Code 訂購編號	Range(d) 夾持範圍	L	L1	D	Min ⁻¹ G2.5 動態平衡	Nut 螺帽	Spanner 扳手
HSK63A-HEC8-100AM	3-8	100	74	30	30,000	CN-HEC8AM	30194-830
HEC12-100AM	4-12	100	74	42	30,000	CN-HEC12AM	30194-842

- The circular nuts can be replaced with the hexagonal nuts.
- Clamping nut design by circular cylinder. Bearing spanner must be used.
- End mill chuck specially designed for hard cutting material.
- Superior surface finish for mold tools and 3-D work.
- Bearing spanner and stop screw must be ordered separately.

- 全圓螺帽可以換成六角螺帽。
- 全圓螺帽，必須使用軸承扳手。
- 專門為難切削材設計的銑刀夾頭。
- 在模具加工時，表面光滑度極佳。
- 軸承扳手及止動螺絲必須另外訂購。



HEC MILLING CHUCK (AC TYPE)

HEC 精銑夾頭刀柄 (AC型)

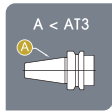
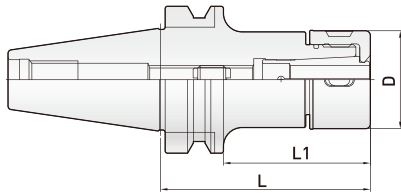

Taper tolerance
錐度公差



Surface roughness
表面粗度

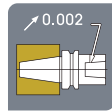

Run out accuracy
內孔偏擺度



Surface hardness
表面硬度

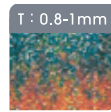

Carbonized depth
滲碳深度

Order Code 訂購編號	L	L1	D	Min ¹ G6.3 動態平衡	Nut 螺帽	Spanner 扳手	Collet 筒夾
BT30-HEC8-75	75	53	30	30,000	CN-HEC8AC	30194-724	HEC8
HEC12-75	75	53	42	30,000	CN-HEC12AC	30194-702	HEC12
BT40-HEC8-90	90	63	30	30,000	CN-HEC8AC	30194-724	HEC8
HEC12-90	90	63	42	30,000	CN-HEC12AC	30194-702	HEC12
BT50-HEC12-100	100	62	42	10,000	CN-HEC12AC	30194-702	HEC12

- End mill chuck specially designed for hard cutting material.
- Superior surface finish for mold tools and 3-D work.
- Spanner and stop screw must be ordered separately.
- 專門為難切削材設計的銑刀夾頭。
- 在模具加工時，表面光滑度極佳。
- 扳手及止動螺絲必須另外訂購。



HEC MILLING CHUCK (AM TYPE)

HEC 精銑夾頭刀柄 (AM型)

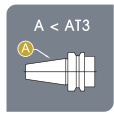
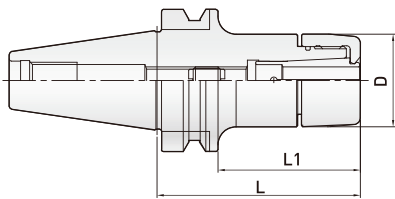

A < AT3

Taper tolerance
錐度公差



Ra ≤ 0.15

Surface roughness
表面粗度

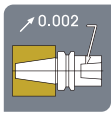

0.002

Run out accuracy
內孔偏擺度



HRc 58±2

Surface hardness
表面硬度

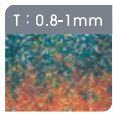

T : 0.8-1mm

Carbonized depth
滲碳深度

Order Code 訂購編號	L	L1	D	Min ⁻¹ G2.5 動態平衡	Nut 螺帽	Spanner 扳手	Collet 筒夾
BT30-HEC8-75AM	75	53	30	30,000	CN-HEC8AM	30194-830	HEC8
HEC12-75AM	75	53	42	30,000	CN-HEC12AM	30194-842	HEC12
BT40-HEC8-90AM	90	63	30	30,000	CN-HEC8AM	30194-830	HEC8
HEC12-90AM	90	63	42	30,000	CN-HEC12AM	30194-842	HEC12

- Clamping nut design by circular cylinder. Bearing spanner must be used.
- End mill chuck specially designed for hard cutting material.
- Superior surface finish for mold tools and 3-D work.
- Bearing spanner and stop screw must be ordered separately.
- 全圓螺帽，必須使用軸承扳手。
- 專門為難切削材設計的銑刀夾頭。
- 在模具加工時，表面光滑度極佳。
- 軸承扳手及止動螺絲必須另外訂購。



HEC COLLET

HEC 筒夾

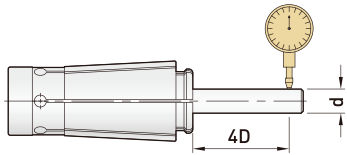

- Runout <math>< 5\mu\text{m}</math> [4×D]
- 跳動精度 <math>< 5\mu\text{m}</math> [4×D]

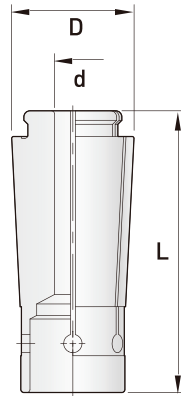

Order Code 訂購編號	d	(d) 持夾徑	L	D
HEC8-3	3	3	35	16
4	4	4		
5	5	5		
6	6	6		
8	8	8		
HEC12-4	4	4	46	20
6	6	6		
8	8	8		
10	10	10		
12	12	12		

HEC NUT (AC TYPE)

HEC 螺帽 (AC型)



Order Code 訂購編號	Outside Dia 外徑	Collet 筒夾規格
CN-HEC8AC	30	HEC8
HEC12AC	42	HEC12

HEC NUT (AM TYPE)

HEC 螺帽 (AM型)



Order Code 訂購編號	Outside Dia 外徑	Collet 筒夾規格
CN-HEC8AM	30	HEC8
HEC12AM	42	HEC12

SPANNER

扳手



Order Code 訂購編號	Type 型式
30194-724	SP-HEC8
702	SP-HEC12



Order Code 訂購編號	Nut 螺帽規格	inside Dia 內徑
30194-830	CN-HEC8AM	30
842	CN-HEC12AM	42

SD

EVERY PRODUCT OF KOJEX
UNDER THE FULL QUALITY
ASSURANCE OF
STRICT EXAMINATION.

每一件廣傑產品
均經嚴格品質檢驗





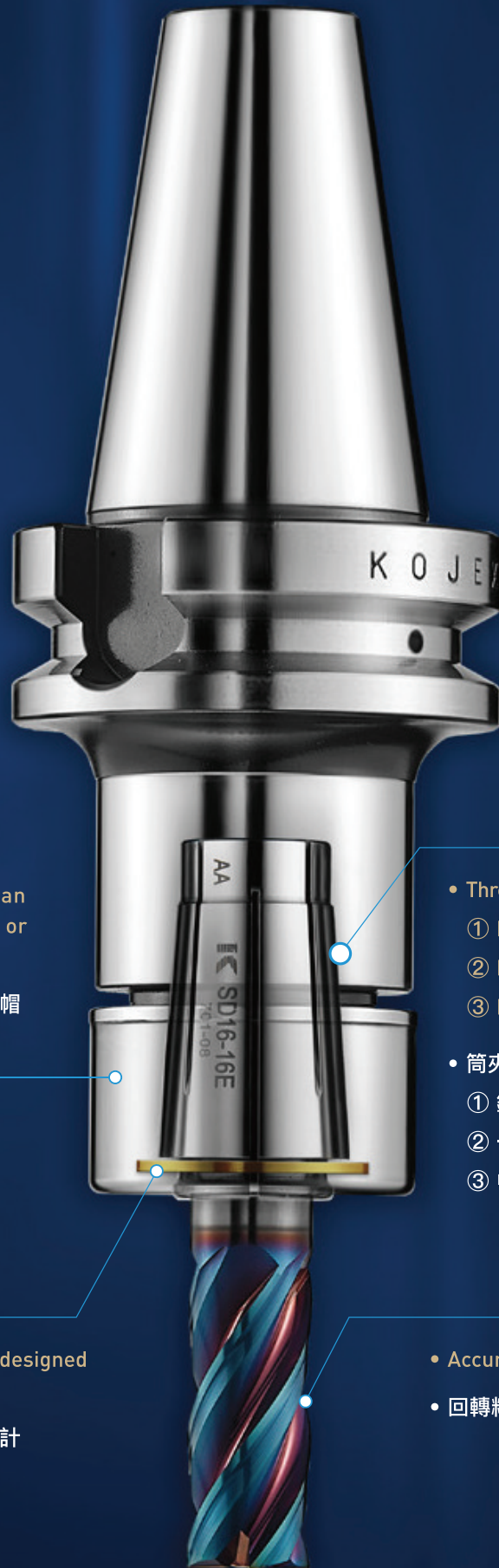

- The clamping nut can choose circular nut or hexagonal nut.
- 螺帽可以選擇全圓螺帽或六角螺帽

- Three types of collets to choose :
 - ① For End mill
 - ② For gripping all type of tools
 - ③ For coolant supply

- 筒夾規格完整,有三大系列 :
 - ① 銑刀專用
 - ② 一般泛用
 - ③ 中心出水

- The clamping nut is designed with flat bearing.
- 螺帽有軸承墊片的設計

- Accuracy < 0.005mm [4XD]
- 回轉精度在0.005mm以下 (4XD)

RUN OUT

Accuracy within 0.005mm at 4 times length of cutter edge to ensure uniform an even cutting action, increasing cutting speed and tool life.

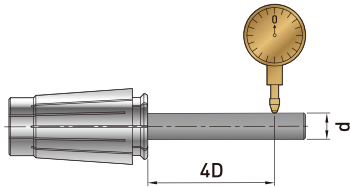

回轉精度

4倍刃長精度在0.005mm以內，確保切削時每刃刀口的均勻切削，可使切削速度提高及刀具壽命增加。

COLLET WITH COOLANT SUPPLY

This is Kojex's original designed with coolant supply, simple and convenient for using, which must be used in combination with the nut.

中心出水筒夾

這是KOJEX獨創的中心出水夾頭，它必須與螺帽合為一組使用，簡單方便。

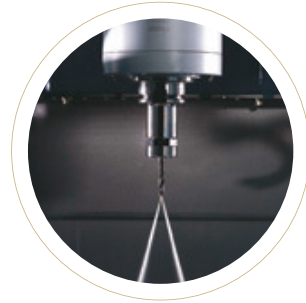

THE CLAMPING NUT IS DESIGNED WITH FLAT BEARING

The bearing nut can increase the clamping force more than 30% and avoid the distortion and deformation of the collet.

螺帽有軸承墊片的設計

可以增加30%以上的鎖固力量及避免筒夾的扭曲變形。

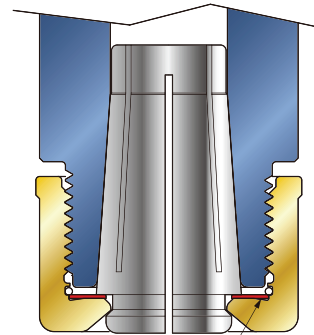

Flat bearing 軸承墊片

SPECIAL FOR END MILL

This is a one-to-one special collet. The maximum locking area of screw teeth [T] and 95% taper area of the collet [K] is covered the collet chuck when the milling process has excellent vibration damping of performance.

銑刀專用的筒夾

這是一對一的專用筒夾，筒夾的斜面 [K] 95% 面積，可與本體貼合，螺牙鎖固面積 [T] 加大，銑刀加工時，具有極佳的阻尼減震效果。

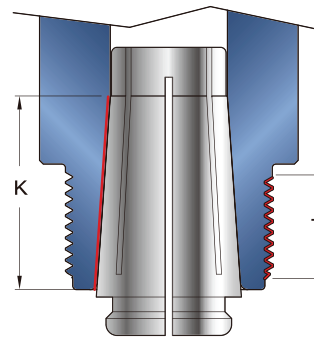

SD PLUS CHUCK (AM TYPE)

SD 高精度夾頭刀柄 (AM型)

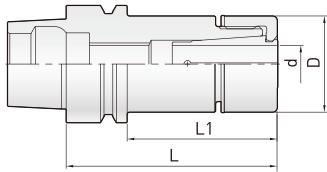

F Type Collet / F型 筒夾

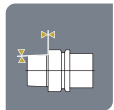

Dual face contact
兩面接觸

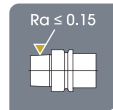

Surface roughness
表面粗度

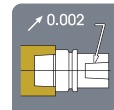

Run out accuracy
內孔偏擺度



Surface hardness
表面硬度

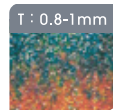

Carbonized depth
滲碳深度

Order Code 訂購編號	Range(d) 夾持範圍	L	L1	D	Min ⁺ G2.5 動態平衡	Nut 螺帽	Spanner 扳手
HSK40E-SD10-70AM	2~10	70	50	30	42,000	CN-SD10AM	30194-830
SD13-70AM	3~13	70	50	35	42,000	CN-SD13AM	30194-835
SD16-70AM	4~16	70	50	42	42,000	CN-SD16AM	30194-842
HSK50E-SD10-70AM	2~10	70	44	30	36,000	CN-SD10AM	30194-830
SD13-70AM	3~13	70	44	30	36,000	CN-SD13AM	30194-835
SD16-70AM	4~16	70	44	35	36,000	CN-SD16AM	30194-842

- Clamping nut design by circular cylinder. Bearing spanner must be used.
- Three types of collet to choose from (1) D type for gripping all type of tools. (2) E type for End mill. (3) F type for coolant supply.
- Bearing spanner and stop screw must be ordered separately.
- The circular nuts can be replaced with the hexagonal nuts.
- 全圓螺帽，必須使用軸承扳手。
- 筒夾有三種類別可選擇 (1) D型：可夾持任何刀具 (2) E型：銑刀專用 (3) F型：中心出水刀具使用。
- 軸承扳手及止動螺絲必須另外訂購。
- 全圓螺帽可以換成六角螺帽。



SD PLUS CHUCK (AC TYPE)

SD 高精度夾頭刀柄 (AC型)

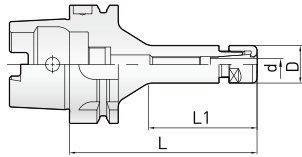

F Type Collet / F型 筒夾

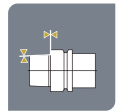

Dual face contact
兩面接觸



Surface roughness
表面粗度

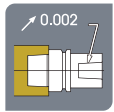

Run out accuracy
內孔偏擺度



Surface hardness
表面硬度

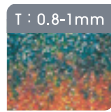

Carbonized depth
滲碳深度

Order Code 訂購編號	Range(d) 夾持範圍	L	L1	D	Min ¹ G6.3 動態平衡	Nut 螺帽	Spanner 板手
HSK63A-SD10-100	2~10	100	74	29	30,000	CN-SD10A	30194-925
SD13-100	3~13	100	66	37	30,000	CN-SD13A	30194-932
SD16-100	4~16	100	74	41	30,000	CN-SD16A	30194-936
SD20-100	6~20	100	74	50	30,000	CN-SD20A	30194-702
HSK100A-SD16-100	4~16	100	56	41	20,000	CN-SD16A	30194-936

- Three types of collet to choose from (1) D type for gripping all type of tools. (2) E type for End mill. (3) F type for coolant supply.
- Spanner and stop screw must be ordered separately.
- The hexagonal nuts can be replaced with the circular nuts.
- 筒夾有三種類別可選擇 (1) D型：可夾持任何刀具 (2) E型：銑刀專用 (3) F型：中心出水刀具使用。
- 扳手及止動螺絲必須另外訂購。
- 六角螺帽可以換成全圓螺帽。



SD

HSK

A 63 / 100

WSD SYNCHRO TAPPING CHUCK

WSD 同步攻牙刀柄 (鋼性攻牙)

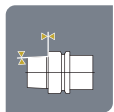
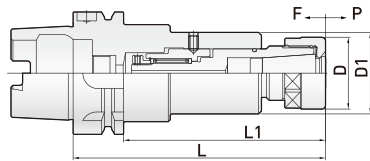

Dual face contact
兩面接觸

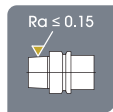

Surface roughness
表面粗度

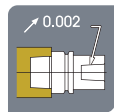

Run out accuracy
內孔偏擺度



Surface hardness
表面硬度

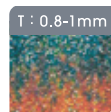

Carbonized depth
滲碳深度

Order Code 訂購編號	Tap 絲攻範圍	F 壓縮量	P 伸長量	L	L1	Nut 螺帽	Spanner 扳手
HSK63A-WSD6-130	M1~M5	0.5	1.0	130	104	CN-SD6A	30194-917
WSD10-130	M3~M10	0.5	1.0	130	104	CN-SD10A	30194-925
WSD13-130	M6~M16	0.5	1.0	130	104	CN-SD13A	30194-932

- With the compression compensation at 0.5mm an accurate thread is maintained ; this is also maintained with the 1mm compensation with the chuck is in tension.
- Internal buffer spring allows compression compensation which reduces the torque by up to 1/3.
- By reducing the torque this increases the quantity and the accuracy of the tapped hole.
- The increase in alignment accuracy extends the life of the tap and improves thread quality.
- 同步攻牙刀柄，壓縮方向補償0.5m/m，拉伸方向補償1m/m給同步(鋼性)攻牙誤差進行補正。
- 壓縮方向補償可使攻牙負荷降低至普通同步攻牙負荷的1/3。
- 拉伸方向補償可使反轉時扭力大幅降低，絲攻不易斷裂。
- 高精度心軸結合，使間隙降至最小，提升攻牙的對心精度。



SD PLUS CHUCK (AC TYPE)

SD 高精度夾頭刀柄 (AC型)

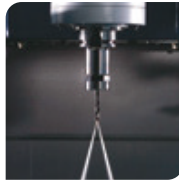
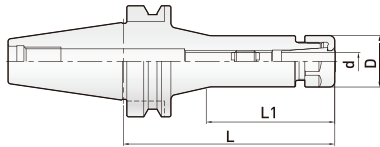

F Type Collet / F型 筒夾

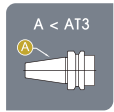

Taper tolerance
錐度公差



Surface roughness
表面粗度

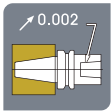

Run out accuracy
內孔偏擺度



Surface hardness
表面硬度

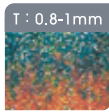

Carbonized depth
滲碳深度

Order Code 訂購編號	Range(d) 夾持範圍	L	L1	D	Min ¹ G6.3 動態平衡	Nut 螺帽	Spanner 板手
BT30-SD6-90	2~6	90	50	20	15,000	CN-SD6A	30194-917
SD10-60	2~10	60	38	29	15,000	CN-SD10A	30194-925
SD10-90	2~10	90	68	29	15,000	CN-SD10A	30194-925
SD13-75	3~13	75	50	37	15,000	CN-SD13A	30194-932
SD16-60	4~16	60	38	41	15,000	CN-SD16A	30194-936
SD16-90	4~16	90	68	41	15,000	CN-SD16A	30194-936
SD20-60	6~20	60	37	50	15,000	CN-SD20A	30194-702
BT40-SD6-90	2~6	90	50	20	12,000	CN-SD6A	30194-917
SD10-60	2~10	60	33	29	12,000	CN-SD10A	30194-925
SD10-90	2~10	90	63	29	12,000	CN-SD10A	30194-925
SD10-120	2~10	120	93	29	12,000	CN-SD10A	30194-925
SD13-75	3~13	75	40	37	12,000	CN-SD13A	30194-932
SD13-90	3~13	90	55	37	12,000	CN-SD13A	30194-932
SD13-120	3~13	120	85	37	12,000	CN-SD13A	30194-932
SD16-60	4~16	60	33	41	12,000	CN-SD16A	30194-936
SD16-90	4~16	90	63	41	12,000	CN-SD16A	30194-936
SD20-90	6~20	90	63	50	12,000	CN-SD20A	30194-702
BT50-SD10-100	2~10	100	62	29	10,000	CN-SD10A	30194-925
SD10-150	2~10	150	70	29	10,000	CN-SD10A	30194-925
SD13-100	3~13	100	47	37	10,000	CN-SD13A	30194-932
SD13-150	3~13	150	97	37	10,000	CN-SD13A	30194-932
SD16-100	4~16	100	62	41	10,000	CN-SD16A	30194-936
SD16-150	4~16	150	112	41	10,000	CN-SD16A	30194-936
SD20-100	6~20	100	62	50	10,000	CN-SD20A	30194-702
SD20-150	6~20	150	112	50	10,000	CN-SD20A	30194-702



- Three types of collet to choose from (1) D type for gripping all type of tools. (2) E type for End mill. (3) F type for coolant supply.
- Spanner and stop screw must be ordered separately.
- 筒夾有三種類別可選擇 (1) D型：可夾持任何刀具 (2) E型：銑刀專用 (3) F型：中心出水刀具使用。
- 扳手及止動螺絲必須另外訂購。

SD

BT

30 / 40 / 50

SD PLUS CHUCK (AM TYPE)

SD 高精度夾頭刀柄 (AM型)

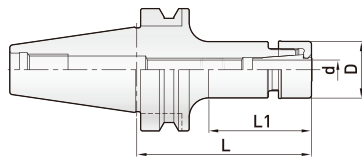

F Type Collet / F型筒夾

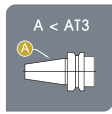

Taper tolerance
錐度公差



Surface roughness
表面粗度

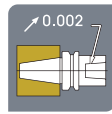

Run out accuracy
內孔偏擺度



Surface hardness
表面硬度

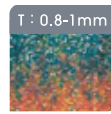

Carbonized depth
滲碳深度

Order Code 訂購編號	Range(d) 夾持範圍	L	L1	D	Min ⁻¹ G2.5 動態平衡	Nut 螺帽	Spanner 板手
BT30-SD6-90AM	2-6	90	50	20	30,000	CN-SD6AM	30194-820
SD10-90AM	2-10	90	68	30	30,000	CN-SD10AM	30194-830
SD13-75AM	3-13	75	50	35	30,000	CN-SD13AM	30194-835
SD16-90AM	4-16	90	68	42	30,000	CN-SD16AM	30194-842
BT40-SD6-90AM	2-6	90	50	20	30,000	CN-SD6AM	30194-820
SD10-90AM	2-10	90	63	30	30,000	CN-SD10AM	30194-830
SD13-90AM	3-13	90	55	35	30,000	CN-SD13AM	30194-835
SD16-90AM	4-16	90	63	42	30,000	CN-SD16AM	30194-842

- Clamping nut design by circular cylinder. Bearing spanner must be used.
- Three types of collet to choose from (1) D type for gripping all type of tools.
(2) E type for End mill. (3) F type for coolant supply.
- Bearing spanner and stop screw must be ordered separately.
- 全圓螺帽，必須使用軸承板手。
- 筒夾有三種類別可選擇 (1) D型：可夾持任何刀具(2) E型：銑刀專用
(3) F型：中心出水刀具使用。
- 軸承板手及止動螺絲必須另外訂購。



WSD SYNCHRO TAPPING CHUCK

WSD 同步攻牙刀柄 (鋼性攻牙)

Experience shows that the synchronization
is not always achieved...

經驗顯示，機器的同步性並不能被保證...

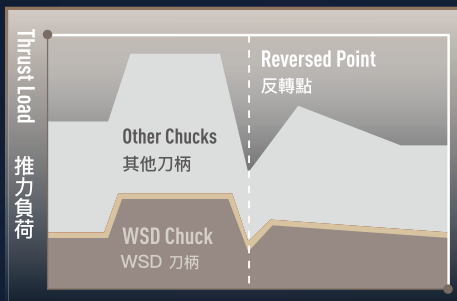

WSD SYNCHRO TAPPING CHUCK

WSD 同步攻牙刀柄 (鋼性攻牙)

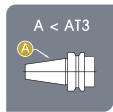
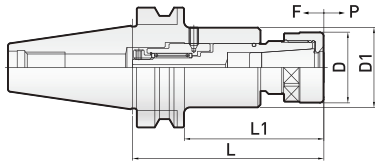

Taper tolerance
錐度公差

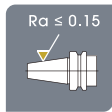

Surface roughness
表面粗度

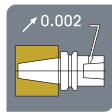

Run out accuracy
內孔偏擺度



Surface hardness
表面硬度

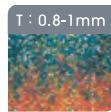

Carbonized depth
滲碳深度

Order Code 訂購編號	Tap 絲攻範圍	F 壓縮量	P 伸長量	L	L1	Nut 螺帽	Spanner 扳手
BT30- WSD6-95	M1-M5	0.5	1.0	95	73	CN-SD6A	30194-917
WSD10-95	M3-M10	0.5	1.0	95	73	CN-SD10A	30194-925
WSD13-95	M6-M16	0.5	1.0	95	73	CN-SD13A	30194-932
BT40- WSD6-100	M1-M5	0.5	1.0	100	73	CN-SD6A	30194-917
WSD10-100	M3-M10	0.5	1.0	100	73	CN-SD10A	30194-925
WSD13-100	M6-M16	0.5	1.0	100	73	CN-SD13A	30194-932
BT50- WSD10-120	M3-M10	0.5	1.0	120	82	CN-SD10A	30194-925
WSD13-120	M6-M16	0.5	1.0	120	82	CN-SD13A	30194-932

- With the compression compensation at 0.5mm an accurate thread is maintained ; this is also maintained with the 1mm compensation with the chuck is in tension.
- Internal buffer spring allows compression compensation which reduces the torque by up to 1/3.
- By reducing the torque this increases the quantity and the accuracy of the tapped hole.
- The increase in alignment accuracy extends the life of the tap and improves thread quality.
- 同步攻牙刀柄，壓縮方向補償0.5mm/m，拉伸方向補償1mm/m給同步(鋼性)攻牙誤差進行補正。
- 壓縮方向補償可使攻牙負荷降低至普通同步攻牙負荷的1/3。
- 拉伸方向補償可使反轉時扭力大幅降低，絲攻不易斷裂。
- 高精度心軸結合，使間隙降至最小，提升攻牙的對心精度。



AZ ADJUSTABLE CHUCK

AZ 可調精度刀柄

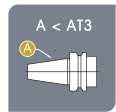
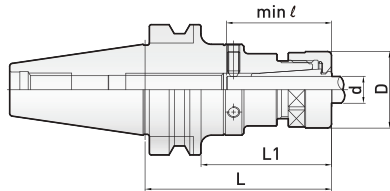

Taper tolerance
錐度公差



Surface roughness
表面粗度

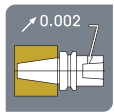

Run out accuracy
內孔偏擺度



Surface hardness
表面硬度

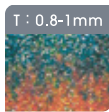

Carbonized depth
滲碳深度

Order Code 訂購編號	Range(d) 夾持範圍	L	L1	Min ℓ 最小長度	T spanner 調整扳手	Nut 螺帽	Spanner 扳手
BT30-SD6-AZ-70	2~6	70	48	35	30194-632	CN-SD6A	30194-917
SD10-AZ-75	2~10	75	53	40	30194-632	CN-SD10A	30194-925
BT40-SD6-AZ-90	2~6	90	63	35	30194-632	CN-SD6A	30194-917
SD10-AZ-90	2~10	90	63	40	30194-632	CN-SD10A	30194-925
SD13-AZ-90	3~13	90	63	49	30194-632	CN-SD13A	30194-932
BT50-SD13-AZ-100	3~13	100	62	49	30194-632	CN-SD13A	30194-932

● The tool tip position can be adjusted as "O" position.

● 刀尖位置可調整至 "O" 位置。

● The accumulated error value of the spindle, the chuck and the tool can all be adjusted and corrected at the same time.

● 機械主軸、夾頭、刀具的累積誤差值可一次調整補正。

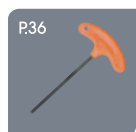

S
D

B
T

30
/
40
/
50

SD PLUS CHUCK (B TYPE)

SD 高精度夾頭刀柄 (B型)

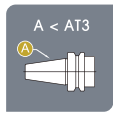
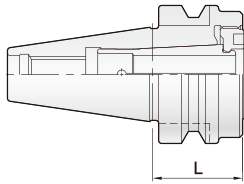

Taper tolerance
錐度公差

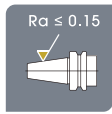

Surface roughness
表面粗度

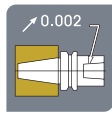

Run out accuracy
內孔偏擺度

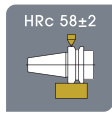

Surface hardness
表面硬度

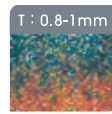

Carbonized depth
滲碳深度

Order Code 訂購編號	L	Min ⁻¹ G2.5 動態平衡	Nut 螺帽	Spanner 扳手	Collet 筒夾
BT40-SD20B-35	35	30,000	CN-SD20B	SP-SD20B	SD20

- Collet and clamping nut are built into the collet chuck.
- Double efficiency for gripping the end mill.
- Spanner must be ordered separately.
- 筒夾及螺帽均內藏本體內。
- 夾持銑刀加工，效率加倍。
- 扳手必須另外訂購。



WSD SYNCHRO TAPPING CHUCK

WSD 同步攻牙刀柄 (鋼性攻牙)

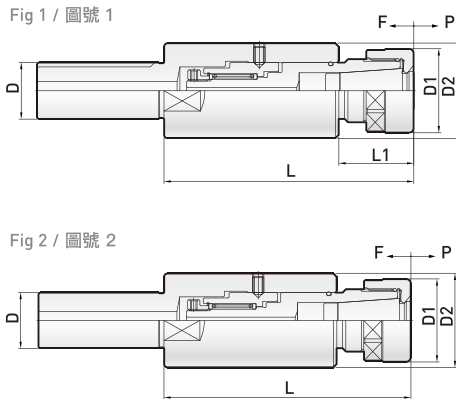
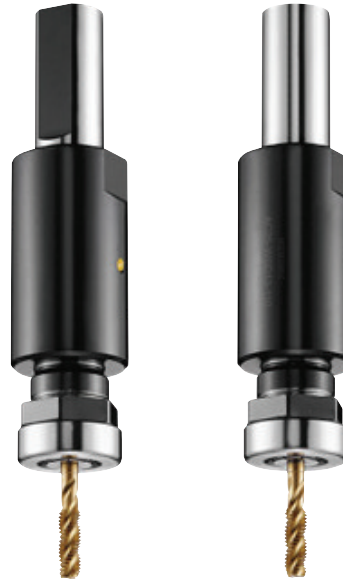

Fig 1 / 圖號 1

Fig 2 / 圖號 2



Order Code 訂購編號	Fig 圖號	Tap 絲攻範圍	F 壓縮量	P 伸長量	L	D	Nut 螺帽	Spanner 扳手規格
SL25-WSD13-110	1	M6~M16	0.5	1.0	110	25	CN-SD13A	30194-932
AC25-WSD13-110	2	M6~M16	0.5	1.0	110	25	CN-SD13A	30194-932

- With the compression compensation at 0.5mm an accurate thread is maintained ; this is also maintained with the 1mm compensation with the chuck is in tension.
- Internal buffer spring allows compression compensation which reduces the torque by up to 1/3.
- By reducing the torque this increases the quantity and the accuracy of the tapped hole.
- The increase in alignment accuracy extends the life of the tap and improves thread quality.

- 同步攻牙刀柄，壓縮方向補償0.5mm/m，拉伸方向補償1mm/m給同步(鋼性)攻牙誤差進行補正。
- 壓縮方向補償可使攻牙負荷降低至普通同步攻牙負荷的1/3。
- 拉伸方向補償可使反轉時扭力大幅降低，絲攻不易斷裂。
- 高精度心軸結合，使間隙降至最小，提升攻牙的對心精度。



SD COLLET (D TYPE)

SD 筒夾 (D型)

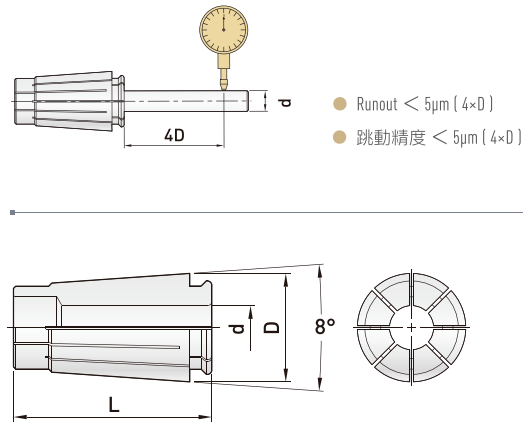

SD6

Order Code 訂購編號	d	Range(d) 夾持範圍	L	D
SD6-2D	2	1.75~2.00	25	11
2.25D	2.25	2.00~2.25		
2.5D	2.5	2.25~2.50		
2.75D	2.75	2.50~2.75		
3D	3	2.75~3.00		
3.5D	3.5	3.00~3.50		
4D	4	3.50~4.00		
4.5D	4.5	4.00~4.50		
5D	5	4.50~5.00		
5.5D	5.5	5.00~5.50		
6D	6	5.50~6.00		

- Gripping range is 0.25mm for collets below 3mm. Gripping range is 0.5mm for collets above 3mm.
- Collets with 3 series, can grip drills, taps, reamers and end mills between 2mm-13mm.
- 3mm以下筒夾，每一個筒夾有0.25mm的夾持範圍；3mm以上筒夾，每一個筒夾有0.5mm的夾持範圍。
- 筒夾分為3大系列，可夾持2mm~13mm的鑽頭、絲攻、絞刀、銑刀。

SD10

Order Code 訂購編號	d	Range(d) 夾持範圍	L	D
SD10-2D	2	1.75~2.00	30	16
2.25D	2.25	2.00~2.25		
2.5D	2.5	2.25~2.50		
2.75D	2.75	2.50~2.75		
3D	3	2.75~3.00		
3.5D	3.5	3.00~3.50		
4D	4	3.50~4.00		
4.5D	4.5	4.00~4.50		
5D	5	4.50~5.00		
5.5D	5.5	5.00~5.50		
6D	6	5.50~6.00		
6.5D	6.5	6.00~6.50		
7D	7	6.50~7.00		
7.5D	7.5	7.00~7.50		
8D	8	7.50~8.00		
8.5D	8.5	8.00~8.50		
9D	9	8.50~9.00		
9.5D	9.5	9.00~9.50		
10D	10	9.50~10.00		

SD13

Order Code 訂購編號	d	Range(d) 夾持範圍	L	D
SD13-3D	3	2.75~3.00	39	20
3.5D	3.5	3.00~3.50		
4D	4	3.50~4.00		
4.5D	4.5	4.00~4.50		
5D	5	4.50~5.00		
5.5D	5.5	5.00~5.50		
6D	6	5.50~6.00		
6.5D	6.5	6.00~6.50		
7D	7	6.50~7.00		
7.5D	7.5	7.00~7.50		
8D	8	7.50~8.00		
8.5D	8.5	8.00~8.50		
9D	9	8.50~9.00		
9.5D	9.5	9.00~9.50		
10D	10	9.50~10.00		
10.5D	10.5	10.00~10.50		
11D	11	10.50~11.00		
11.5D	11.5	11.00~11.50		
12D	12	11.50~12.00		
12.5D	12.5	12.00~12.50		
13D	13	12.50~13.00		

SD COLLET (E TYPE)

SD 筒夾 (E型)

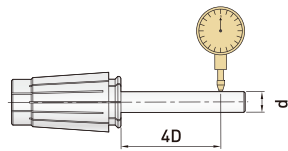

- Runout $< 5\mu\text{m} (4 \times D)$
- 跳動精度 $< 5\mu\text{m} (4 \times D)$

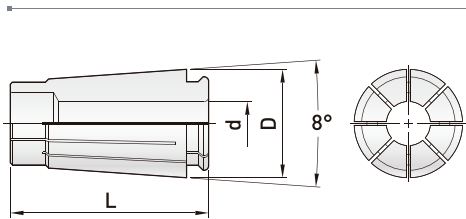

- Gripping torque of SD-E collets is 20% more than SD-D Collets. Can reach high stability during milling.
- Special designed for end mill.

- SD-E筒夾比SD-D筒夾多20%的夾持力，在夾持銑刀加工時，更為安定。
- 立銑刀專用夾頭。

SD6

Order Code 訂購編號	d	(d) 持夾徑	L	D
SD6-3E	3	3	25	11
4E	4	4		
6E	6	6		
1/8E	3.175	3.175		

SD10

Order Code 訂購編號	d	(d) 持夾徑	L	D
SD10-3E	3	3	30	16
4E	4	4		
5E	5	5		
6E	6	6		
8E	8	8		
10E	10	10		
1/8E	3.175	3.175		

SD13

Order Code 訂購編號	d	(d) 持夾徑	L	D
SD13-3E	3	3	39	20
4E	4	4		
5E	5	5		
6E	6	6		
8E	8	8		
10E	10	10		
12E	12	12		
1/8E	3.175	3.175		

SD16

Order Code 訂購編號	d	(d) 持夾徑	L	D
SD16-4E	4	4	45	25
5E	5	5		
6E	6	6		
8E	8	8		
10E	10	10		
12E	12	12		
14E	14	14		
16E	16	16		

SD20

Order Code 訂購編號	d	(d) 持夾徑	L	D
SD20-6E	6	6	50	30
8E	8	8		
10E	10	10		
12E	12	12		
14E	14	14		
16E	16	16		
20E	20	20		

SD COLLET (F TYPE)

SD 筒夾 (F型)

- SD-F collet provide through-coolant capability.
- The collet combine with nut.
- SD-F筒夾具有中心出水的功能。
- 筒夾出貨時，內含螺帽。



F Type Collet / F型 筒夾



Fig 2 / 圖號 2



Fig 1 / 圖號 1

Order Code 訂購編號	Chuck Type 刀柄規格	(d) 持夾徑	Contains 內容		Fig 圖號		
			Collet 筒夾	Nut 螺帽			
SAC10- 3F	SD10	3	SD10- 3F	CN-SD10A	1		
4F		4	4F				
6F		6	6F				
8F		8	8F				
10F		10	10F				
SAM10- 3F		3	SD10- 3F	CN-SD10AM	2		
4F		4	4F				
6F		6	6F				
8F		8	8F				
10F		10	10F				
SAC13- 3F	SD13	3	SD13- 3F	CN-SD13A	1		
4F		4	4F				
5F		5	5F				
6F		6	6F				
8F		8	8F				
10F		10	10F				
12F		12	12F				
SAM13- 3F		3	SD13- 3F	CN-SD13AM	2		
4F		4	4F				
5F		5	5F				
6F		6	6F				
8F		8	8F				
10F	10	10F					
12F	12	12F					
SAC16- 6F	SD16	6	SD16- 6F	CN-SD16A	1		
8F		8	8F				
10F		10	10F				
12F		12	12F				
14F		14	14F				
16F		16	16F				
SAM16- 6F		6	SD16- 6F			CN-SD16AM	2
8F		8	8F				
10F		10	10F				
12F		12	12F				
14F		14	14F				
16F		16	16F				

SD NUT (AC TYPE)

SD 螺帽 (AC型)



Fig 1 / 圖號 1

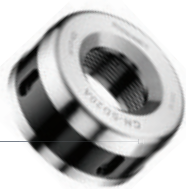

Fig 2 / 圖號 2

Order Code 訂購編號	Fig 圖號	Outside Dia 外徑	Collet 筒夾規格
CN-SD6A	1	20	SD6
SD10A	1	29	SD10
SD13A	1	37	SD13
SD16A	1	41	SD16
SD20A	2	50	SD20

SD NUT (AM TYPE)

SD 螺帽 (AM型)



Order Code 訂購編號	Outside Dia 外徑	Collet 筒夾規格
CN-SD6AM	20	SD6
SD10AM	30	SD10
SD13AM	35	SD13
SD16AM	42	SD16

SD NUT (B TYPE)

SD 螺帽 (B型)



Order Code 訂購編號	Collet 筒夾規格
CN-SD20B	SD20

SPANNER

扳手



Fig 1 / 圖號 1



Fig 2 / 圖號 2

Order Code 訂購編號	Fig 圖號	Type 型式
30194-917	1	SP-SD6
925	1	SP-SD10
932	1	SP-SD13
936	1	SP-SD16
702	2	SP-SD20



Order Code 訂購編號	Type 型式	Nut 螺帽規格
30194-820	SP-SR20	SD6AM
30194-830	SP-SR30	SD10AM
30194-835	SP-SR35	SD13AM
30194-842	SP-SR42	SD16AM



Order Code 訂購編號
SP-SD20B

HPC

INCREASING TOOL
EFFICIENCY STARTS FROM
THE CHUCK

提升刀具效率從夾頭開始

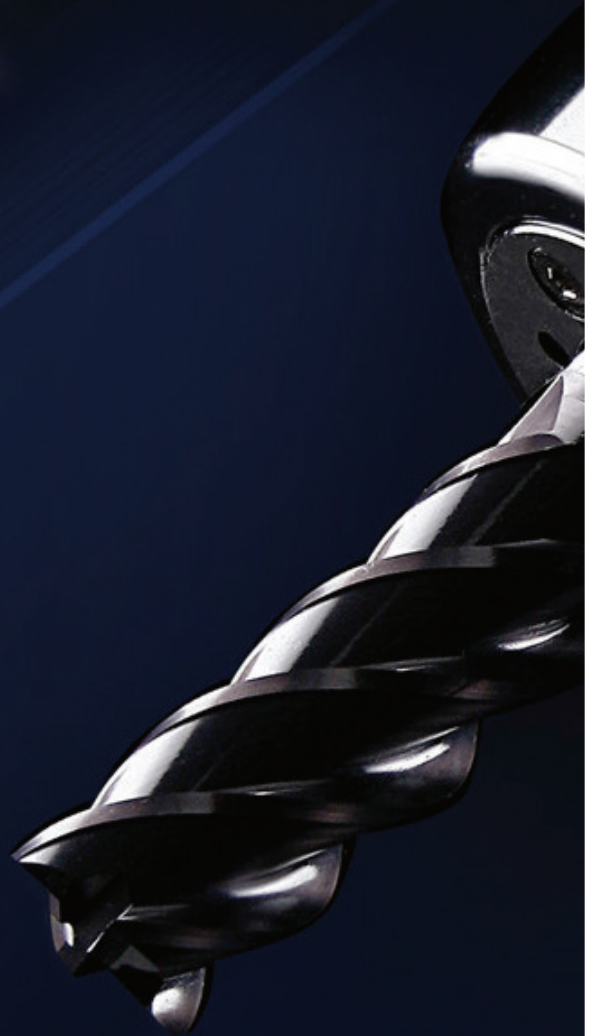



KOJEX



- The designed by needle bearing bring the powerful clamping force.
- 針狀軸承結構具有強力的鎖固力量

- Two types for choose, with center coolant or with side coolant.
- 可以選擇中心出水或側面出水

- The chuck without collet have $\varnothing 12, \varnothing 16, \varnothing 20, \varnothing 25, \varnothing 32$.
- 不含筒夾的本體規格有 $\varnothing 12, \varnothing 16, \varnothing 20, \varnothing 25, \varnothing 32$.

- Accuracy $< 0.005\text{mm}$ (4XD) [without collet]
- 回轉精度在 0.005mm 以下 (4XD) (不含筒夾)

RUN OUT

Accuracy within 0.005mm at 4 times length of cutter edge to ensure uniform an even cutting action, increasing cutting speed and tool life.

回轉精度

4倍刃長精度在0.005mm以內，確保切削時每刃刀口的均勻切削，可使切削速度提高及刀具壽命增加。

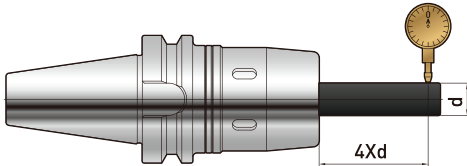

THE DESIGNED WITH THE NEEDLE BEARING STRUCTURE

The needle bearing have the strong clamping force to arrive the maximum locking capacity up to 3200Nm.

針狀軸承結構

具有強力的鎖固力量，最大的鎖固力可達3200Nm。



DESIGNED BY THICK WALL

The thick wall can absorb the cutting tool vibration to achieve the effect of vibration damping.

厚壁設計

可以吸收切削時的刀具震動，達到阻尼減震的效果。



CHOICE OF COOLING MODE

Through the change of the sealing cover below, you can select the center coolant or side coolant.

冷却方式的選擇

經由下面封蓋的改變，可以選擇中心出水或側面出水。



COMPLETE RANGED OF SPECIFICATIONS

The chuck without collet have $\varnothing 12$, $\varnothing 16$, $\varnothing 20$, $\varnothing 25$, $\varnothing 32$. The chuck without collet can ensure that the grip will not be reduced.

系統規格完整

不含筒夾的本體規格有 $\varnothing 12$ 、 $\varnothing 16$ 、 $\varnothing 20$ 、 $\varnothing 25$ 、 $\varnothing 32$ ，沒有筒夾的本體，可以確保把握力不會減少。

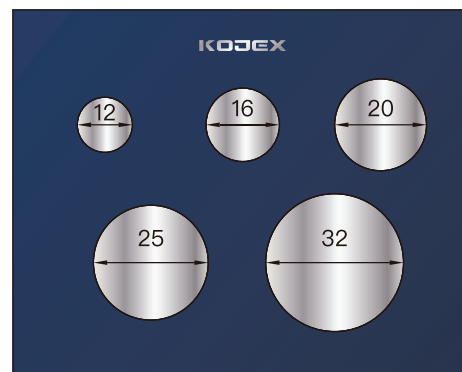

HPC POWERGRIP CHUCK

HPC 威力夾頭刀柄

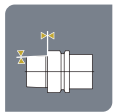
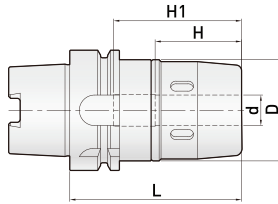

Dual face contact
兩面接觸



Surface roughness
表面粗度

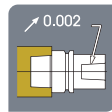

Run out accuracy
內孔偏擺度

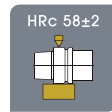

Surface hardness
表面硬度

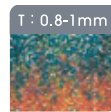

Carbonized depth
滲碳深度

Order Code 訂購編號	L	D	d	H	H1	Min ¹ G6.3 動態平衡	Spanner 扳手
HSK63A-HPC12-85	85	43	12	43	60	30,000	30194-702
HPC16-90	90	53	16	43	60	30,000	30194-703
HPC20-105	105	57	20	47	75	30,000	30194-704
HPC25-110	110	62	25	57	80	30,000	30194-704
HPC32-120	120	76	32	60	87	30,000	30194-705
HSK100A-HPC25-120	120	62	25	57	85	20,000	30194-704

- Designed by needle bearing, bring powerful clamping force.
- Suitable for process on high speed and heavy cutting.
- Spanner must be ordered separately.
- H=min tool length / H1=max tool length.
- 採用針狀軸承設計，夾持力極佳。
- 可同時在高速切削和重切削上使用。
- 扳手必須另外訂購。
- H=最短銑刀柄長度/H1=最長銑刀柄長度。



HPC POWERGRIP CHUCK

HPC 威力夾頭刀柄

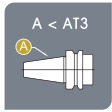
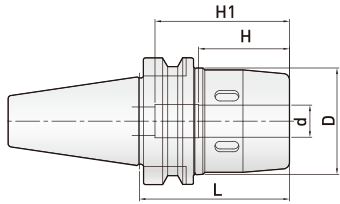

Taper tolerance
錐度公差

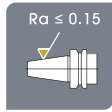

Surface roughness
表面粗度

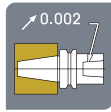

Run out accuracy
內孔偏擺度



Surface hardness
表面硬度

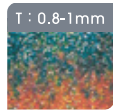

Carbonized depth
滲碳深度

Order Code 訂購編號	L	D	d	H	H1	Min ⁻¹ G6.3 動態平衡	Spanner 扳手
BT30- HPC12-80	80	43	12	43	60	30,000	30194-702
HPC16-90	90	53	16	43	66	30,000	30194-703
HPC20-90	90	57	20	47	90	30,000	30194-704
BT40- HPC12-85	85	43	12	43	60	30,000	30194-702
HPC16-90	90	53	16	43	76	30,000	30194-703
HPC20-90	90	57	20	47	90	30,000	30194-704
HPC25-95	95	63	25	57	90	30,000	30194-704
HPC32-110	110	76	32	60	100	30,000	30194-705
BT50- HPC12-100	100	43	12	43	170	20,000	30194-702
HPC16-100	100	53	16	43	170	20,000	30194-703
HPC20-100	100	57	20	47	170	20,000	30194-704
HPC25-105	105	63	25	57	90	20,000	30194-704
HPC25-150	150	63	25	57	90	20,000	30194-704
HPC32-110	110	76	32	60	100	20,000	30194-705

- Designed by needle bearing, bring powerful clamping force.
- Suitable for process on high speed and heavy cutting.
- Spanner must be ordered separately.
- H=min tool length / H1=max tool length.

- 採用針狀軸承設計，夾持力極佳。
- 可同時在高速切削和重切削上使用。
- 扳手必須另外訂購。
- H=最短銑刀柄長度/H1=最長銑刀柄長度。



H
P
C

B
T

30
/
40
/
50

HPC COLLET

HPC 筒夾

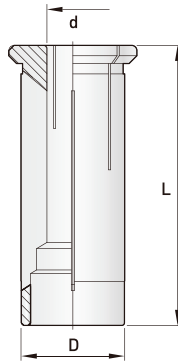

Order Code 訂購編號	d	(d) 夾持徑	L	D
HPC20- 6	6	6	54	20
8	8	8		
10	10	10		
12	12	12		
16	16	16		
HPC25- 8	8	8	60	25
10	10	10		
12	12	12		
16	16	16		
20	20	20		
HPC32- 10	10	10	72	32
12	12	12		
16	16	16		
20	20	20		
25	25	25		

SPANNER

扳手



Order Code 訂購編號	Type 型式
30194-702	SP-HPC12
703	SP-HPC16
704	SP-HPC20/HPC25
705	SP-HPC32

PULL STUDS

拉桿螺絲

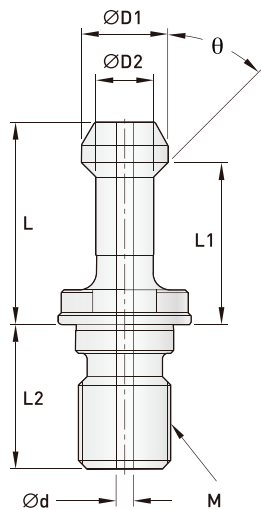

P30T / P40T / P50T

Order Code 訂購編號	Type 型式	Shank 刀柄	ØD1	ØD2	Ød	L	L1	L2	Ø	M
33000-100	P30T-1	BT30	11	7	--	23	18	20	45°	M12
200	P30T-2	BT30	11	7	--	23	18	20	60°	M12

34000-100	P40T-1	BT40	15	10	--	35	28	25	45°	M16
200	P40T-2	BT40	15	10	--	35	28	25	60°	M16

35000-100	P50T-1	BT50	23	17	--	45	35	40	45°	M24
200	P50T-2	BT50	23	17	--	45	35	40	60°	M24

P40T / P50T with coolant hole (中心油孔)

Order Code 訂購編號	Type 型式	Shank 刀柄	ØD1	ØD2	Ød	L	L1	L2	Ø	M
34000-1001	P40T-1H	BT40	15	10	3	35	28	25	45°	M16
35000-1001	P50T-1H	BT50	23	17	5	45	35	40	45°	M24

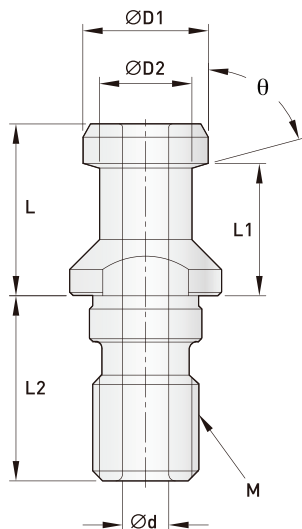

JIS6339 with coolant hole (中心油孔)

Order Code 訂購編號	Type 型式	Shank 刀柄	ØD1	ØD2	Ød	L	L1	L2	Ø	M
34000-401	40PH (JIS6339)	BT40	19	14	7	29	23	25	75°	M16
35000-401	50PH (JIS6339)	BT50	28	21	10	34	25	40	75°	M24

DIN69872 with coolant hole (中心油孔)

Order Code 訂購編號	Type 型式	Shank 刀柄	ØD1	ØD2	Ød	L	L1	L2	Ø	M
33000-404	DIN69872-30	SK30	13	9	--	24	19	20	75°	M12
34000-404	DIN69872-40	SK40	19	14	7	26	20	28	75°	M16
35000-404	DIN69872-50	SK50	28	21	11.5	34	25	40	75°	M24

MAZAK with coolant hole (中心油孔)

Order Code 訂購編號	Type 型式	Shank 刀柄	ØD1	ØD2	Ød	L	L1	L2	Ø	M
34000-1510	PYN40	BT40	18.8	12.45	7	19.11	14.03	25	45°	M16
35000-1510	PYN50	BT50	28.96	20.83	10	25.2	17.58	40	45°	M24

SPANNER FOR PULL STUDS

拉桿螺絲扳手



Order Code 訂購編號	Type of Pull Stud 拉桿螺絲型式
SP-BT30-45	P30T-1
SP-BT40-45	P40T-1
SP-BT50-45	P50T-1

COOLANT SUPPLY UNIT

冷卻液套管

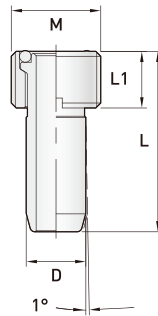

Order Code 訂購編號	L	L1	D	M
HSK63A-M18	36	11.4	12	M18 P1.5

SD / HEC

CLEAN / 清潔

- To maintain high precision, you must always clean the clamping nut, collet and collet chuck prior to assembly.
- 為維持良好精度，請在組裝前，將本體螺帽及筒夾的內徑及外徑，確實做好清潔工作。

USER MANUAL

TECHNOLOGY HUMANITY

使用說明

INSTALL / 組裝

- 1 Stand the collet on a table.
將筒夾直立桌面上(大徑向上)。
- 2 Push the clamping nut onto the collet until you hear a "click" sound.
將螺帽往下壓入筒夾，聽到"卡"一聲，即完成。
- 3 Put the cutting tool into the collet and tighten until the tool fixed.
刀具插入筒夾內孔中並與螺帽一起鎖入本體，直到刀具固定不動。
- 4 Put the chuck in the tool locking fixture and use the spanner to lock the clamping nut.
本體放入鎖刀座，以扳手將螺帽鎖緊。



DISASSEMBLE / 拆卸

- 1 Position the chuck in the tool locking fixture and use the spanner on the clamping nut to loosen.
將本體放入鎖刀座，以扳手將螺帽鬆開。
- 2 Loosen the clamping nut by hand until you can remove it from the chuck completely.
用手將螺帽繼續鬆開，直到完全離開本體。
- 3 Remove the tool and separate the collet from the clamping nut by hand.
取出刀具後，用手將螺帽與筒夾分開。
- 4 Clean the dust and metal filings from the clamping nut, collet and holder with an air gun.
用空氣槍，將本體螺帽及筒夾的內外徑表面所殘留的粉塵及鐵屑吹乾淨。



- 5 Apply anti-corrosion agent for longevity of the collet.
用油布擦拭，做好防銹工作。



● UC / DC

CLEAN / 清潔

- To maintain high precision, you must always clean both the collet and collet chuck prior to assembly.
- 為維持良好精度，請在組裝前，將本體及筒夾的內徑及外徑，確實做好清潔工作。

INSTALL / 組裝

- 1 Insert the cutting tool into the collet.
將刀具插入筒夾內。
- 2 Rotate the hexagonal spanner clockwise to fix the tool and collet.
將筒夾與刀具由本體前端推入。用T型六角扳手由本體後端放入以順時鐘方向，將筒夾及刀具固定。
- 3 Put the chuck in the tool locking fixture and lock the tool with a torque wrench. (for recommended torque value please check the catalogue)
將本體放入鎖刀座，以扭力扳手將筒夾及刀具鎖緊(推薦扭力值請參閱目錄)。



DISASSEMBLE / 拆卸

- 1 Position the chuck in the tool locking fixture. Then rotate the hexagonal spanner counter-clockwise two times to loosen the tool and collet.
將本體放入鎖刀座，以T型六角扳手，由後端放入，以逆時鐘方向旋轉，二段式退出筒夾與刀具。
- 2 Remove the cutting tool and collet.
取出筒夾與刀具。
- 3 Clean the dust and metal filings from the collet and holder with an air gun.
用空氣槍，將本體及筒夾的內外徑表面所殘留的粉塵及鐵屑吹乾淨。
- 4 Apply anti-corrosion agent for longevity of the collet.
用油布擦拭，做好防銹工作。

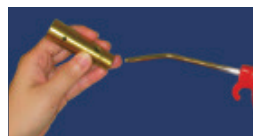



KOJEX MACHINERY INDUSTRIAL CO., LTD.

廣傑機械工業股份有限公司

No.25, 24th Road, Taichung Industrial Park, Taichung 40850, Taiwan
40850台灣台中市南屯區工業24路25號

TEL : + 886 - 4 - 23598055

FAX : + 886 - 4 - 23593427

E-mail : saec@ms25.hinet.net

www.kojex.com.tw

